

Register your instrument!
www.eppendorf.com/myeppendorf



Eppendorf ThermoStat C

Operating manual

Copyright ©2014 Eppendorf AG, Germany. All rights reserved, including graphics and images. No part of this publication may be reproduced without the prior permission of the copyright owner.

Eppendorf® and the Eppendorf logo are registered trademarks of Eppendorf AG, Germany.

Eppendorf ThermoMixer®, Eppendorf ThermoTop®, and *condens.protect*® are registered trademarks of Eppendorf AG, Germany.

Registered trademarks and protected trademarks are not marked in all cases with ® or ™ in this manual.

Table of contents

1	Operating instructions	5
1.1	Using this manual	5
1.2	Danger symbols and danger levels	5
1.2.1	Danger symbols	5
1.2.2	Danger levels	5
1.3	Symbols used	6
1.4	Abbreviations used	6
1.5	Glossary	6
2	Product description	7
2.1	Main illustration	7
2.2	Delivery package	7
2.3	Features	8
3	Safety	9
3.1	Intended use	9
3.2	User profile	9
3.3	Information on product liability	9
3.4	Warnings for intended use	10
3.5	Danger symbols on the device	13
4	Installation	14
4.1	Selecting the location	14
4.2	Installing the instrument	14
5	Operation	15
5.1	Overview of operating controls	15
5.2	Setting the language	17
5.3	Installing the thermoblock	17
5.3.1	Attaching the thermoblock	19
5.3.2	Removing the thermoblock	19
5.4	Inserting tubes and plates	19
5.5	Installing the ThermoTop	21
5.6	Temperature control	22
5.6.1	Temperature control with time setting	22
5.6.2	Temperature control with continuous run	23
5.6.3	Interrupting time counting	23
5.6.4	Temperature control with Temp Control or Time Control	24
5.7	Menu	25
5.7.1	Navigating in the menu	25
5.7.2	Menu structure	25

4 Table of contents
Eppendorf ThermoStat C
English (EN)

5.8	Programs	27
5.8.1	Creating a program	27
5.8.2	Restricting ramp rates	28
5.8.3	Loading a saved program	29
5.8.4	Editing programs	30
5.8.5	Deleting programs	30
6	Troubleshooting	31
6.1	General errors	31
6.2	Error messages	32
7	Maintenance	33
7.1	Setting service intervals	33
7.2	Cleaning	33
7.2.1	Cleaning the thermoblock	34
7.3	Disinfection/Decontamination	34
7.4	Decontamination before shipment	35
7.5	Verification of temperature control	35
8	Transport, storage and disposal	36
8.1	Transport	36
8.2	Storage	36
8.3	Disposal	36
9	Technical data	37
9.1	Power supply	37
9.2	Weight/dimensions	37
9.3	Ambient conditions	37
9.4	Application parameters	38
9.4.1	Temperature control	38
9.4.2	Time setting	38
9.5	Interface	38
10	Ordering information	39
10.1	Device and accessories	39
10.2	Tubes and plates	40
10.3	Temperature Verification System	41
11	Program data form	42
	Index	43
	Certificates	45

1 Operating instructions









1.1 Using this manual

- ▶ Read this operating manual completely before using the device for the first time. Also observe the instructions for use of the accessories.
- ▶ This operating manual is part of the product. Thus, it must always be easily accessible.
- ▶ Enclose this operating manual when transferring the device to third parties.
- ▶ You will find the current version of the operating manual for all available languages on our webpage under www.eppendorf.com.

1.2 Danger symbols and danger levels

The safety instructions of this operating manual indicate the following danger symbols and danger levels:

1.2.1 Danger symbols

	Biohazard		Explosion
	Electric shock		Hot surface
	Hazard point		Risk of fire
	Crushing		Material damage

1.2.2 Danger levels

DANGER	<i>Will</i> lead to severe injuries or death.
WARNING	<i>May</i> lead to severe injuries or death.
CAUTION	May lead to light to moderate injuries.
NOTICE	May lead to material damage.

1.3 Symbols used

Depiction	Meaning
1. 2.	Actions in the specified order
▶	Actions without a specified order
•	List
<i>Text</i>	Display text or software text
i	Additional information

1.4 Abbreviations used

PCR

Polymerase chain reaction

1.5 Glossary

Deepwell plate Plate with 48, 96 or 384 wells with a larger volume than microplates. Suitable for the preparation, mixing, centrifuging, transporting and storing of solid and liquid samples.



Lid Lid for the thermoblock. Ensures uniform temperature control and protects samples from unwanted exposure to light.

Microplate Plate with 24, 48, 96 or 384 wells for the preparation, mixing, centrifuging, transporting and storing of solid and liquid samples.

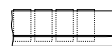

PCR plate Plate with 96 or 384 wells for PCR applications.

ThermoTop Heated cover for the thermoblock. Prevents the formation of condensation on the inner wall or the lid of the tube thanks to the *condens.protect* technology.

Well Concave vessel of a microplate, PCR plate or deepwell plate.

2 Product description
2.1 Main illustration

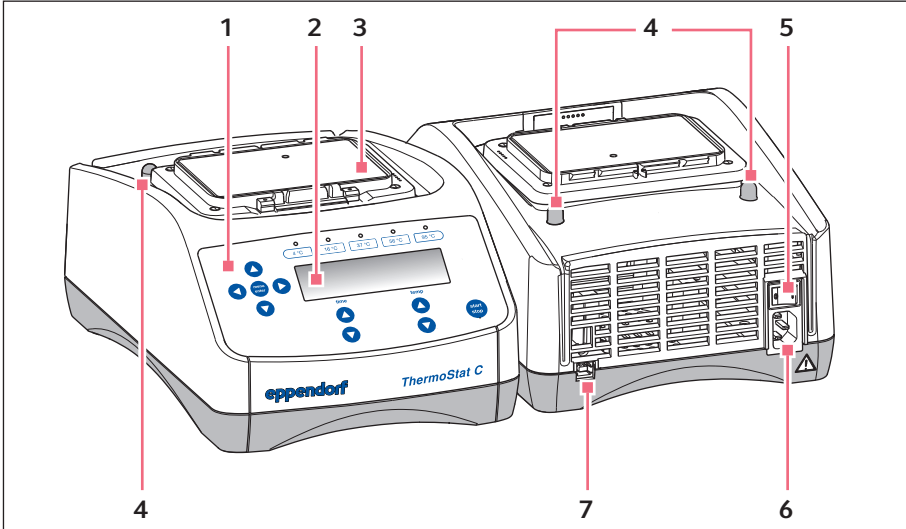

- | | |
|-------------------------|--|
| 1 Operating controls | 5 Power switch |
| 2 Display | 6 Power connection socket |
| 3 Heating/cooling plate | 7 USB interface (for Eppendorf Service only) |
| 4 Centering pins | |

2.2 Delivery package

Quantity	Order no. (International)	Order no. (North America)	Description
1	5383 000.019	5383000027	ThermoStat C basic device without thermoblock
1	–	–	Mains/power cord
1	5383 900.010		Operating Manual ThermoStat C
1	5383 900.028		Short Instructions ThermoStat C



- ▶ Check the delivery for completeness.
- ▶ Check all parts for damage in transit.
- ▶ To safely transport and store the device, keep the transport box and packing material.

2.3 Features

The ThermoStat C makes it possible to temper liquids effectively within a range from -10 °C (max. 30 °C below ambient temperature) to 110 °C.

The thermoblocks can be exchanged quickly and easily, without the use of tools. The thermoblocks allow the use of lab tubes in the microliter and milliliter ranges:

- Tubes (e.g., Eppendorf Safe-Lock Tubes with volumes of 0.2 mL to 5.0 mL)
- Conical tubes with volumes of 15 mL and 50 mL
- Microplates and deepwell plates with any kind of bottom shape
- PCR plates (e.g., Eppendorf twin.tec PCR Plate 96, Eppendorf twin.tec PCR Plate 384)
- Tubes with a diameter of 11 mm to 11.9 mm
- Cryotubes

Temperature control

- **Interrupt time counting:** If you want to add reagents or exchange tubes during temperature control, you can interrupt time counting without interrupting the temperature control procedure.
- **Multi-level temperature control:** In addition to a simple temperature control run, you can freely program programs with up to four successive levels ("steps"). The temperature and duration of each level are freely selectable. The program levels automatically run one after the other.
- A total of 15 program slots is available.
- The 5 most common temperatures (4 °C, 16 °C, 37 °C, 56 °C, 95 °C) can be directly selected.

Lid and ThermoTop

- The Lid ensures uniform temperature control and protects samples from unwanted exposure to light.
- The ThermoTop prevents the formation of condensation on the inner wall or the lid of the tube thanks to the *condens.protect* technology.

3 Safety

3.1 Intended use

The ThermoStat C is intended for use in a molecular biology laboratory.

The ThermoStat C is designed for the temperature control of liquids in closed tubes and closed plates for the preparation and processing of samples.

The ThermoStat C is exclusively intended for use indoors. All country-specific safety requirements for operating electrical equipment in the laboratory must be observed.

Only use Eppendorf accessories or accessories recommended by Eppendorf.

3.2 User profile

The device and accessories may only be operated by trained and skilled personnel.

Before using the device, read the operating manual carefully and familiarize yourself with the device's mode of operation.

3.3 Information on product liability

In the following cases, the designated protection of the device may be compromised. Liability for any resulting property damage or personal injury is then transferred to the operator:

- The device is not used in accordance with the operating manual.
- The device is used outside of its intended use.
- The device is used with accessories or consumables which are not recommended by Eppendorf.
- The device is maintained or repaired by people not authorized by Eppendorf.
- The user makes unauthorized changes to the device.

3.4 Warnings for intended use

Read the operating instructions and observe the following general safety information before using the ThermoStat C.

**DANGER! Risk of explosion.**

- ▶ Do not operate the device in areas where work is completed with explosive substances.
- ▶ Do not use this device to process any explosive or highly reactive substances.
- ▶ Do not use this device for processing any substances which could generate an explosive atmosphere.

**DANGER! Electric shock as a result of penetration of liquid.**

- ▶ Switch off the device and disconnect the power plug before starting cleaning or disinfection work.
 - ▶ Do not allow any liquids to penetrate the inside of the housing.
 - ▶ Use closed tubes and closed plates.
 - ▶ Do not spray clean/spray disinfect the housing.
 - ▶ Only plug the device back in if it is completely dry, both inside and outside.
-

**WARNING! Electric shock due to damage to device or mains cable.**

- ▶ Only switch on the device if the device and mains cable are undamaged.
- ▶ Only use devices that have been properly installed or repaired.
- ▶ In case of danger, disconnect the device from the mains supply by pulling the power plug from the device or the mains socket or, by using the isolating device intended for this purpose (e.g., emergency stop switch in the laboratory).

**WARNING! Lethal voltages inside the device.**

Touching parts which are under high voltage may cause an electric shock. An electric shock injures the heart and causes respiratory paralysis.

- ▶ Ensure that the housing is closed and undamaged.
 - ▶ Do not remove the housing.
 - ▶ Ensure that no liquid can penetrate into the device.
- Only authorized service staff may open the device.



WARNING! Risk from incorrect supply voltage

- ▶ Only connect the device to voltage sources which correspond to the electrical requirements on the name plate.
- ▶ Only use sockets with a protective earth (PE) conductor and suitable power cable.



WARNING! Risk of burns from hot surfaces.

The thermoblock and the heating/cooling plate can be very hot after heating and cause burns.

- ▶ Allow the thermoblock and heating/cooling plate to cool down completely before removing the thermoblock.



WARNING! Personal injury or material damage due to chemically or mechanically damaged thermoblocks.

- ▶ Do not use thermoblocks that show signs of corrosion or mechanical damage.
- ▶ Regularly check the condition of the thermoblocks.



WARNING! Damage to health due to infectious liquids and pathogenic germs.

- ▶ When handling infectious liquids and pathogenic germs, observe the national regulations, the biological security level of your laboratory, the material safety data sheets, and the manufacturer's application notes.
- ▶ Wear personal protective equipment.
- ▶ For comprehensive regulations about handling germs or biological material of risk group II or higher, please refer to the "Laboratory Biosafety Manual" (source: World Health Organization, Laboratory Biosafety Manual, in its respectively current valid version).



WARNING! Risk of fire.

- ▶ Do not use this device to process any highly flammable liquids.



WARNING! Damage to health due to contaminated device and accessories.

- ▶ Decontaminate the device and the accessories before storage and shipping.



WARNING! Risk of injury due to incorrect consumables.

- Glass tubes can smash.
 - ▶ Only use the thermoblocks with the consumables designed for them.
 - ▶ Never use tubes made of glass or other fragile material.

**WARNING! Contamination due to opening seals of consumables.**

In the following cases, the seals of tubes can spring open. Sample material can escape.

- high vapor pressure of the content
 - improperly sealed cover
 - damaged sealing lip
 - improperly fastened foil
- ▶ Always check that consumables have been sealed tightly before use.

**CAUTION! Poor safety due to incorrect accessories and spare parts.**

The use of accessories and spare parts other than those recommended by Eppendorf may impair the safety, functioning and precision of the device. Eppendorf cannot be held liable or accept any liability for damage resulting from the use of incorrect or non-recommended accessories and spare parts, or from the improper use of such equipment.

- ▶ Only use accessories and original spare parts recommended by Eppendorf.

**NOTICE! Damage to the display due to mechanical pressure.**

- ▶ Do not apply mechanical pressure to the display.

**NOTICE! Damage from overheating.**

- ▶ Do not install the device near to any heat sources (e.g., heating, drying cabinet).
- ▶ Do not expose the device to direct sunlight.
- ▶ Ensure unobstructed air circulation. Keep free a clearance of at least 10 cm (3.9 in) around all ventilation grilles.

**NOTICE! Damage to electronic components due to condensation.**

Condensate can form in the device after it has been moved from a cool environment to a warmer environment.



- ▶ After installing the device, wait at least for 3 h. Only then connect the device to the mains.



NOTICE! Damage from the use of aggressive chemicals.

- ▶ Do not use any aggressive chemicals on the device or its accessories, such as strong and weak bases, strong acids, acetone, formaldehyde, halogenated hydrocarbons or phenol.
- ▶ If the device has been contaminated by aggressive chemicals, immediately clean it by means of a mild cleaning agent.

3.5 Danger symbols on the device

Representation	Meaning	Location
	Risk of burns from hot surfaces.	Upper device side On the thermoblock
	▶ Observe the operating manual.	Rear of the device

4 **Installation**

4.1 Selecting the location

Select the device location according to the following criteria:

- Mains/power connection in accordance with the name plate
- Minimum distance to other devices and walls: 10 cm (3.9 in)
- Resonance free table with horizontal even work surface
- The design of table is suitable for operating the device.
- The design of table is suitable for operating the device.
- Surrounding area must be well ventilated.
- The location must be protected against direct sunlight.



The mains/power switch and cutting unit of the mains/power line must be easily accessible during operation (e.g., residual current circuit breaker).

4.2 Installing the instrument



WARNING! Risk from incorrect supply voltage

- ▶ Only connect the device to voltage sources which correspond to the electrical requirements on the name plate.
 - ▶ Only use sockets with a protective earth (PE) conductor and suitable power cable.
-

1. Place the ThermoStat C on a suitable work surface.
Position the device in such a way that the ventilation slots of the device are not obstructed.
2. Connect the power cable to the power connection socket of the device and the power supply.

5 Operation
5.1 Overview of operating controls

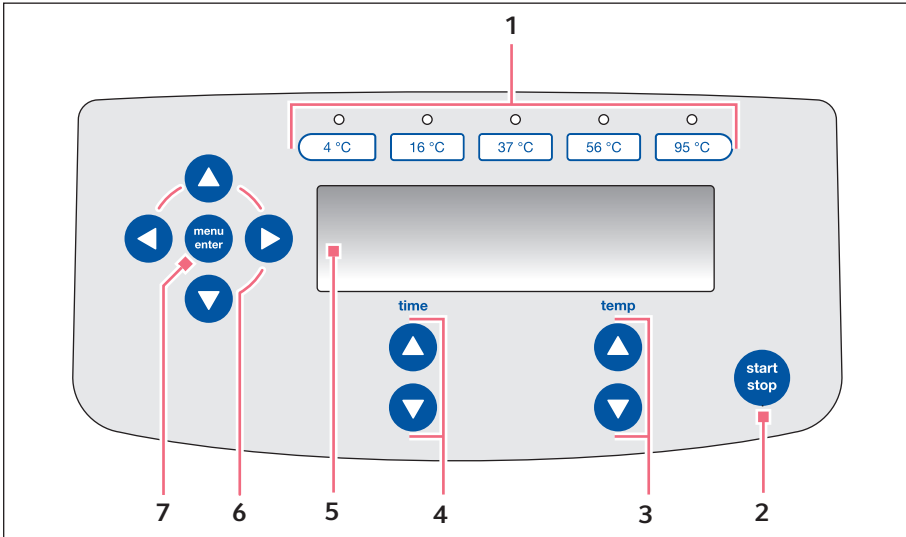

Fig. 5-1: Operating controls

- | | |
|---|--|
| <p>1 Temperature keys with control LEDs</p> <p>2 start/stop key
 start/stop: Start or stop temperature control
 Keep start/stop pressed for 2 s: Pause (interrupt time counting)</p> <p>3 Arrow keys temp
 Set temperature
 Keep the arrow key pressed: quick setting
 As soon as the target temperature is modified, the device begins to perform temperature control.</p> <p>4 Arrow keys time
 Set the temperature control duration
 Keep the arrow key pressed: quick setting</p> | <p>5 Display</p> <p>6 Menu arrow keys
 Navigate the menu: load or edit programs, set key lock, set the time mode, edit the settings.</p> <p>7 menu/enter key
 Open menu
 Confirm your selection</p> |
|---|--|

Operation

Eppendorf ThermoStat C
English (EN)

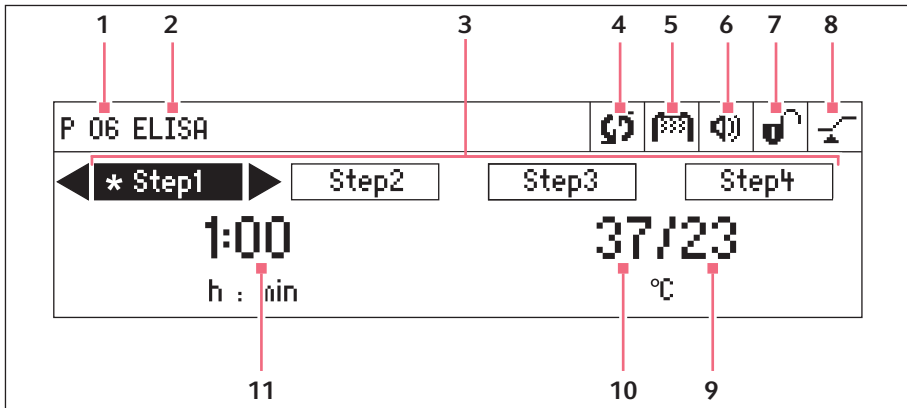











Fig. 5-2: DisplayThermoStat C

- | | |
|--|---|
| <p>1 Program number</p> <p>2 Program name</p> <p>3 Program levels (step 1 to step 4)
*: Current step</p> <p>4 Device status
☺ Device in temperature control mode.
 Time counting interrupted.</p> <p>5 ThermoTop
☺ ThermoTop has been attached.
To prevent condensation, the device heats up the ThermoTop, before controlling the temperature of the thermoblock.</p> <p>6 Speaker
☺ Speaker switched on.
☹ Speaker switched off.</p> | <p>7 Key lock
☺ Key lock activated: parameters cannot be changed.
☹ No key lock.</p> <p>8 Time mode
☹ <i>Time Control</i> Time counting begins immediately.
☺ <i>Temp Control</i> Time counting begins when the set temperature has been reached.</p> <p>9 Actual temperature</p> <p>10 Set temperature
When the set temperature has been reached, only one value is displayed.</p> <p>11 Temperature control duration</p> |
|--|---|

5.2 Setting the language

The device is delivered with *English* as the default language. To set another language, proceed as follows:

1.		Switch on the device with the power switch at the rear of the device.
2.		To open the menu, press the menu/enter key.
3.		Select the <i>Settings</i> menu item with the menu arrow keys.
4.		To confirm your selection, press the menu/enter key.
5.		Select the <i>Language</i> menu item with the menu arrow keys. Confirm with the menu/enter key.
6.	    	Select the language with the menu arrow keys and press the menu/enter key. A tick appears in front of the selected language.
7.		To exit the menu, press the left menu arrow key several times.

5.3 Installing the thermoblock



WARNING! Personal injury or material damage due to chemically or mechanically damaged thermoblocks.

- ▶ Do not use thermoblocks that show signs of corrosion or mechanical damage.
- ▶ Regularly check the condition of the thermoblocks.



WARNING! Contamination due to opening seals of consumables.

In the following cases, the seals of tubes can spring open. Sample material can escape.

- high vapor pressure of the content
- improperly sealed cover
- damaged sealing lip
- improperly fastened foil

- ▶ Always check that consumables have been sealed tightly before use.

Operation

Eppendorf ThermoStat C

English (EN)

When you attach the thermoblock, the device automatically recognizes the mounted thermoblock. The temperature is automatically limited to the maximum value for the thermoblock being used.

Only the following thermoblocks can be used with the ThermoStat C. Exchangeable thermoblocks for the Thermostat plus are not compatible.

Thermoblock	Tubes/Plates	Maximum temperature	Accessories
SmartBlock <i>0.5 mL</i>	Tube volume 0.5 mL	100 °C	ThermoTop or Lid
SmartBlock <i>1.5 mL</i>	Tube volume 1.5 mL	100 °C	ThermoTop or Lid
SmartBlock <i>2.0 mL</i>	Tube volume 2.0 mL	100 °C	ThermoTop or Lid
SmartBlock <i>5.0 mL</i>	Tube volume 5.0 mL	100 °C	–
SmartBlock <i>12 mm</i>	Tubes with a diameter of 11 mm to 11.9 mm	110 °C	–
SmartBlock <i>cryo</i>	Cryotubes	110 °C	–
SmartBlock <i>15 mL</i>	Conical tubes volume 15 mL	100 °C	–
SmartBlock <i>50 mL</i>	Conical tubes volume 50 mL	100 °C	–
SmartBlock <i>plates</i>	Microplates with various bottom contours	100 °C	ThermoTop or Lid
SmartBlock <i>PCR 96</i>	96-well PCR plates 0.2 mL PCR tubes	100 °C	ThermoTop or Lid
SmartBlock <i>PCR 384</i>	384-well PCR plates	100 °C	ThermoTop or Lid



SmartBlock *12 mm* and SmartBlock *cryo*: temperature control up to 110 °C possible.

- ▶ Use only tubes that are suitable for tempering up to 110 °C.

5.3.1 Attaching the thermoblock

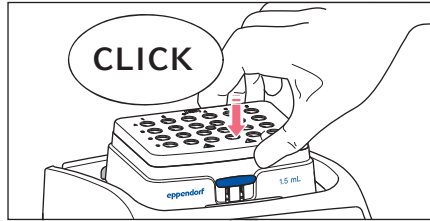
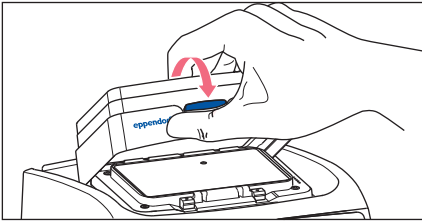

1. First only attach the rear edge of the thermoblock. The writing must face to the front.
2. Push the front edge of the thermoblock down.
 - The thermoblock audibly engages.
 - The display shows the name of the thermoblock.

5.3.2 Removing the thermoblock



WARNING! Risk of burns from hot surfaces.

The thermoblock and the heating/cooling plate can be very hot after heating and cause burns.

- ▶ Allow the thermoblock and heating/cooling plate to cool down completely before removing the thermoblock.

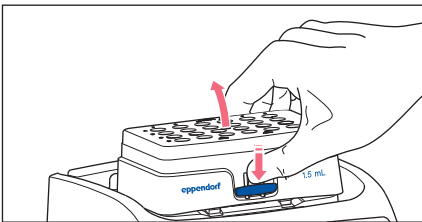

1. To unlock the thermoblock, press the lever at the front of the thermoblock down.
2. Lift the front edge so that the thermoblock is tilted backwards.
3. Remove the thermoblock upwards.

5.4 Inserting tubes and plates



WARNING! Risk of injury due to incorrect consumables.

- Glass tubes can smash.
- ▶ Only use the thermoblocks with the consumables designed for them.
- ▶ Never use tubes made of glass or other fragile material.



NOTICE! Damage to plates due to too high temperatures.

Polystyrene microplates melt at temperatures above 70 °C.
Polypropylene deepwell plates deform at temperatures above 80 °C. Deformed plates can become detached from the thermoblock.

- ▶ Only heat microplates up to 70 °C.



NOTICE! Material change of consumables due to extreme temperatures.

Extreme temperatures (e.g., during refrigeration or autoclaving) affect consumables material. The mechanical strength, dimensions and shape of the consumable will change.

- ▶ Use consumables that are suitable for the selected temperature range or selected procedure.



The height sensor of the SmartBlock *plates* automatically differentiates between deepwell plates and microplates.

- ▶ When inserting microplates, make sure that the height sensor is not covered.
- ▶ Take care that the height sensor does not get contaminated.
- ▶ Place the suitable thermoblock on the device (see *Attaching the thermoblock on p. 19*).

Inserting the plate

- ▶ Insert the plate with the back edge first. Then press it down at the front.

Inserting tubes

- ▶ Insert the tubes completely into the bores of the thermoblock.

SmartBlock *plates*, SmartBlock PCR 96 or SmartBlock PCR 384:

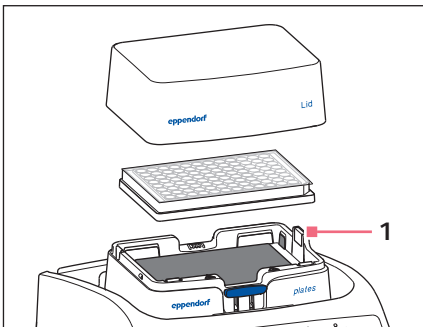

1 Height sensor

- ▶ To ensure uniform temperature control, place the lid on the thermoblock.

5.5 Installing the ThermoTop

The ThermoTop is compatible with thermoblocks which feature the *condens.protect* symbol: 

The *condens.protect* technology available with ThermoTop prevents the formation of condensation on the inner wall or the lid of the tube.

Prerequisites

- A compatible thermoblock has been attached.
- Tubes or plates have been inserted.

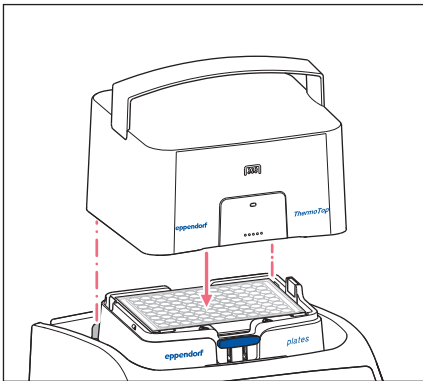

- ▶ Place the ThermoTop on the device vertically from above. The centering pins behind the heating/cooling plate fit into the recesses of the ThermoTop.
- The ThermoTop is correctly positioned if the seal is fully flush with the upper part of the device.
- The blue LED of the ThermoTop lights.
- The  symbol appears in the display.

Functioning principle of the ThermoTop

- In order to prevent the formation of any condensate in a reliable manner, the device first heats the ThermoTop until it reaches the set temperature. The tempering of the thermoblock occurs with a delay.
- The temperature sensor of the thermoblock reacts to the temperature of samples: after inserting samples into a pre-heated thermoblock, the displayed actual temperature may fall temporarily.
- While the device is tempering, the blue LED of the ThermoTop is flashing.

5.6 Temperature control



NOTICE! Damage to electronic components due to condensation.

Condensate can form in the device after it has been moved from a cool environment to a warmer environment.

- ▶ After installing the device, wait at least for 3 h. Only then connect the device to the mains.

The ThermoStat C can be used for temperature control in a range of 30 °C below the ambient temperature to 110 °C.



- When the actual temperature flashes on the display, the device is not in temperature control mode operation.
- As soon as the set temperature is changed with the **temp** arrow keys, the device begins to perform temperature control.
- When the set temperature has been reached, the display only shows one value.

5.6.1 Temperature control with time setting

Prerequisites

The time mode is set to *Time Control* (see p. 24)

1. Using the **time** arrow keys set the temperature control duration.
2. Using the **temp** arrow keys set the temperature.

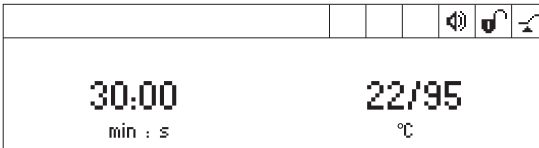

3. To start time counting, press the **start/stop** key.
 - The symbol flashes on the display.
 - The temperature control duration is counted down.
 - The display shows the remaining temperature control duration and the actual temperature/set temperature.
 - A signal sounds after the temperature control duration has elapsed.

5.6.2 Temperature control with continuous run

i **Icing of the thermoblock**

Ice may form on the thermoblock if samples are tempered at low temperatures for a long time.

1. To perform temperature control for an unlimited period of time, use the **time** arrow keys to select the ∞ setting (▼ below 15 s or ▲ above 99:30 h).
2. Using the **temp** arrow keys set the temperature.

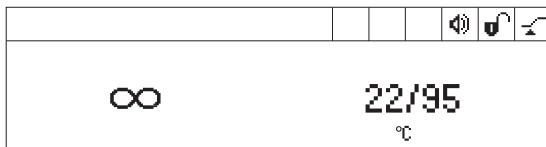

The device immediately starts to perform temperature control.

3. To start time counting, press the **start/stop** key.
 - The  symbol flashes on the display.
 - The temperature control duration is counted up.
 - The display alternately shows the temperature control duration and the ∞ symbol as well as the actual temperature/set temperature
4. To end the temperature control procedure, press the **start/stop** key.
 - A signal sounds.
 - The display shows the last used parameters.

i In the continuous run mode, a temperature control duration of more than 99:30 h is possible. After 99:30 h has elapsed, the display only shows the ∞ symbol.

5.6.3 Interrupting time counting

If you want to add reagents or exchange tubes during temperature control, you can interrupt time counting without interrupting the temperature control procedure.

1. To interrupt time counting, keep the **start/stop** key pressed for 2 s.



- The display alternately shows the temperature control duration and *Pause*.
 - Temperature control is continued.
2. To continue time counting, press the **start/stop** key.

Operation

Eppendorf ThermoStat C

English (EN)

5.6.4 Temperature control with *Temp Control* or *Time Control***You can specify when time counting should begin:**

- Time counting begins immediately: *Time Control*
- Time counting begins when the set temperature has been reached: *Temp Control*

1. Under *Menu* select the *Menu/Time Mode* menu item.

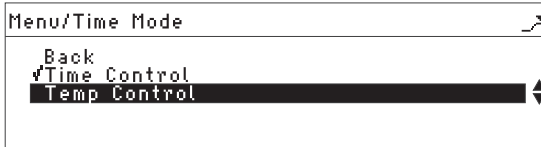





2. Use the menu arrow keys to select *Time Control* or *Temp Control*.
A tick indicates the selected setting.
3. To exit the menu, press the left ◀ menu arrow key twice.

5.7 Menu

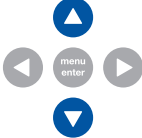

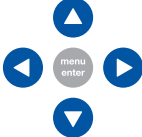



5.7.1 Navigating in the menu

The menu has 3 levels. To change settings, proceed as follows:

1.		To open the menu, press the menu/enter key.
2.		Select the menu item with the menu arrow keys.
3.		To confirm your selection, press the menu/enter key.
4.		Change the settings with the menu arrow keys.
5.		To confirm the changed setting, press the menu/enter key A tick appears in front of the setting.
6.		To exit the menu level, select the <i>Back</i> menu item and press the menu/enter key.

5.7.2 Menu structure

Menu items and options	Description	Symbol on the display
Programs	List with 15 program spaces	
<ul style="list-style-type: none"> Load saved program Create program Edit program Delete program 	<ul style="list-style-type: none"> Select the program from the program list: <i>Menu > Programs > Load</i> Start the program with the start/stop key Save the set parameters (temperature control duration and temperature) on a free program space. You can save up to 4 sets of parameters as automatically consecutive program levels ("steps"). Overwrite saved program or save it to a new program space. Delete the saved program. 	

Menu items and options	Description	Symbol on the display
Key lock <ul style="list-style-type: none"> • <i>Key lock on</i> • <i>Key lock off</i> 	<ul style="list-style-type: none"> • Parameters cannot be changed. • Parameters can be changed. 	 
Time mode <ul style="list-style-type: none"> • <i>Time Control</i> • <i>Temp Control</i> 	<ul style="list-style-type: none"> • Time counting and temperature control begin immediately. • Time counting only begins when the set temperature has been reached. 	 
Settings <ul style="list-style-type: none"> Signal tones <ul style="list-style-type: none"> • Volume • Repetitions Language Contrast Service 	<ul style="list-style-type: none"> • The signal tone for error messages is always output at medium volume level regardless of the speaker settings. • Set the volume of the speaker: <i>20 %, 40 %, 60 %, 80 %, 100 %</i> • Switching the speaker off: <i>0 %</i> • Set repetitions of the signal tone. <i>1 x, 5 x, 10 x, 30 x, Unlimited</i> • Set the language: <i>English, German, French, Italian, Spanish</i> • Set the contrast: <i>0 %, 25 %, 50 %, 75 %, 100 %</i> • Set the service interval: <i>After 500 operating hours</i> <i>After 1000 operating hours</i> <i>After 2000 operating hours</i> <i>No notification</i> 	 

Go to next higher menu level: *Back*

Exit menu item without saving: *Cancel*

Save set value: *Save*



The temperature keys as well as the *Programs* and *Time Mode* menu items are locked while time counting is active.

5.8 Programs

A program consists of up to four program levels ("steps"). The program levels automatically run one after the other. You can save separate settings for each program level:

- Temperature control duration
- Temperature
- Program levels with restricted ramp rates.

The program ends automatically.



The ThermoStat C has 15 program slots.

At the end of this operating manual there is a printed form of a program table. The program data can be noted there.

5.8.1 Creating a program

1. In order to open the menu, keep the **menu/enter** key pressed.
2. Use the menu arrow keys to select the *Programs* menu item. Confirm with the **menu/enter** key.
3. Use the menu arrow keys to select an empty program space. Confirm with the **menu/enter** key.

P 06		
Cancel	Save	Options
01:00		37
h : min		°C

5.8.1.1 Creating a single-level program

1. Set the temperature control duration and the temperature with the **time** and **temp** arrow keys.
2. Use the menu arrow keys to select *Save*. Confirm with the **menu/enter** key.

Entering the program name

P 06		
Cancel	Save	
◀	A B C D E F G H I J K L M N O P Q R S T U V W X Y Z 1 2 3 4 5 6 7 8 9 0 _ ←	

3. Select letters or numbers with the menu arrow keys and confirm with the **menu/enter** key.

The program name can have a maximum of 15 characters.

In order to delete individual characters, select ← and press the **menu/enter** key.

4. In order to save the program with the program name, use the menu arrow keys to select *Save*.
5. Select the program space with the menu arrow keys. Confirm with the **menu/enter** key.

Operation

Eppendorf ThermoStat C
English (EN)

5.8.1.2 Creating a multi-level program

1. Select an empty program space in the *Menu > Programs* menu item.

Defining step 1

2. Set the temperature control duration and temperature for the first program step with the **time** and **temp** arrow keys.

Adding step 2

3. Select *Options*. Confirm with the **menu/enter** key.

P 06 /Options	
Back	
Add step	◀▶
Delete step	
Ramp rates	

4. Select *Add step*. Confirm with the **menu/enter** key.

P 06		
Cancel	Save	◀ Options ▶
Step 1	01h:00m	37 °C
Step 2	10m:00s	56 °C

The set parameters have been adopted in step 1.

5. Set the parameters for the second program level.

- In order to save the program with 2 program levels, select *Save*.
- In order to program a third and a fourth program level, respectively select *Options > Add step*.



In order to delete a step from a program, select *Options > Delete step*.

5.8.2 Restricting ramp rates

You can use the ThermoStat C to choke the heating rate as well as the cooling rate. Restricted ramp rates can only be specified for programs.

Tab. 5-1: Heating rates and cooling rates

Heating rate	max. 3.0 °C/min	max. 2.0 °C/min	max. 1.0 °C/min	max. 0.1 °C/min
Cooling rate	max. 3.0 °C/min	max. 2.0 °C/min	max. 1.0 °C/min	max. 0.1 °C/min

1. Select an empty program space under *Menu > Programs*.
2. Set the temperature control duration and the temperature with the **time** and **temp** arrow keys.
3. Select *Options*. Confirm with the **menu/enter** key.
4. Select *Ramp rates*. Confirm with the **menu/enter** key.

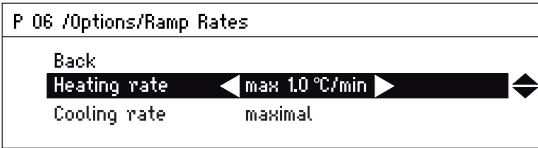

5. Use the menu arrow keys to select and change *Heating rate* or *Cooling rate* .
6. In order to leave the *Ramp rates* menu, select the *Back* menu item. Confirm with the **menu/enter** key.

i When you start a program that runs with restricted heating or cooling rates, a message is displayed: *The program's ramp rates are restricted.*

5.8.3 Loading a saved program

5.8.3.1 Loading a saved temperature

The keys above the display allow you to quickly select the temperature for setting a temperature control value for an unlimited time.

	Temperature	Temperature control duration
4 °C key	4°C	∞
16 °C key	16°C	∞
37 °C key	37°C	∞
56 °C key	56°C	∞
95 °C key	95°C	∞

1. In order to call up a saved temperature, press a (4 °C to 95 °C) key.
 - The LED above the key lights blue.
 - The display shows saved parameters.
2. In order to start the temperature control procedure, press the **start/stop** key.

5.8.3.2 Loading a program from the program list

1. In order to load a program from the program list, select the program under *Menu > Programs*. Confirm with the **menu/enter** key.
2. Use the menu arrow keys to select the *Load* menu item. Confirm with the **menu/enter** key.
 - The display shows the parameters of the program.
 - Programs with several program levels:

The display shows the parameters of the first program level. To display the parameters of the other program levels, use the ◀ or ▶ menu arrow keys to select the corresponding step.

Operation

Eppendorf ThermoStat C

English (EN)

3. In order to start the program, press the **start/stop** key.

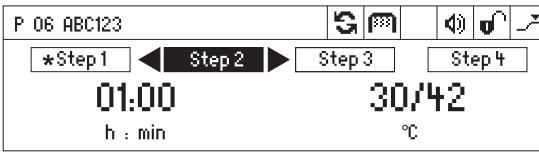

The asterisk marks the active program level Step 1. The display shows the parameters of Step 2.

5.8.4 Editing programs

There are two ways to change a saved program:

- Changing the program via the *Edit* menu item in the program list
- Changing the program during operation

5.8.4.1 Changing the program via the *Edit* menu item in the program list

1. In order to change the parameters of a program, select the program under *Menu > Programs*. Confirm with the **menu/enter** key.
2. Use the menu arrow keys to select the *Edit* menu item. Confirm with the **menu/enter** key.
The display shows the saved parameters.

You can change all parameters and save them (see *Creating a program on p. 27*).

5.8.4.2 Changing the program during operation

1. Load the program with the program keys or from the program list.
2. Change the parameters.
For programs with program levels: Use the ◀ or ▶ menu arrow keys to select a step, change the parameters of the step.
3. Start the program.
After completion of the program, a message appears stating that the program has been changed. You can confirm or discard the changes.



5.8.5 Deleting programs

1. In order to delete a program, select the program under *Menu > Programs*. Confirm with the **menu/enter** key.
2. Use the menu arrow keys to select the *Delete* menu item. Confirm with the **menu/enter** key.
The display shows the message *Confirm delete*. In order to confirm, press the **menu/enter** key.

6 Troubleshooting

If you cannot remedy an error with the recommended measures, please contact your local Eppendorf partner. The contact address can be found online at: www.eppendorf.com.

6.1 General errors

Problem	Cause	Solution
Display remains dark.	<ul style="list-style-type: none"> No mains connection. 	<ul style="list-style-type: none"> ▶ Check the mains connection and the power supply. ▶ Switch the device on.
Set temperature is not reached.	Set temperature is more than 30 °C below ambient temperature.	<ul style="list-style-type: none"> ▶ Set up the device in a cooler environment.
ThermoTop LED does not light.	<ul style="list-style-type: none"> No thermoblock has been attached The thermoblock is not compatible with ThermoTop. 	<ul style="list-style-type: none"> ▶ Use a compatible thermoblock with a <i>condens.protect</i> symbol: 
	<ul style="list-style-type: none"> The interface between the device and the ThermoTop is dirty. 	<ul style="list-style-type: none"> ▶ Remove any dirt from the front of the ThermoTop. ▶ Remove any dirt from the top of the device, especially from the viewing window beside the heating/cooling plate.
ThermoTop does not fit on the device.	<ul style="list-style-type: none"> The thermoblock is not compatible with ThermoTop. The lid is attached to the thermoblock. 	<ul style="list-style-type: none"> ▶ Use a compatible thermoblock with a <i>condens.protect</i> symbol:  ▶ If using the ThermoTop, do not use the lid.
Device is not tempering.	Various causes are possible.	<ul style="list-style-type: none"> ▶ Contact your local Eppendorf partner.

6.2 Error messages

Problem	Cause	Solution
<i>Thermoblock not recognized</i>	<ul style="list-style-type: none"> • Thermoblock is not compatible with the device. • The thermoblock is not attached properly. 	<ul style="list-style-type: none"> ▶ Use a compatible thermoblock. ▶ Remove the thermoblock and then reattach it.
	<ul style="list-style-type: none"> • The interface between the device and the thermoblock is dirty. 	<ul style="list-style-type: none"> ▶ Remove any dirt from the underside of the thermoblock. ▶ Remove any dirt from the top of the device, especially from the viewing window beside the heating/cooling plate.
Error message preceded by a number code.	<ul style="list-style-type: none"> • Various causes are possible. 	<ol style="list-style-type: none"> 1. Switch off device and wait 10 seconds. 2. Switch on device. <p>If the error message appears again, contact your local Eppendorf partner.</p>

7 Maintenance

7.1 Setting service intervals

The ThermoStat C offers the option of activating a reminder that the device needs to be serviced. To set a service interval, proceed as follows:

1. Under *Menu > Settings >* select the *Service* menu item. Confirm with the **menu/enter** key.
2. Select a service interval with the menu arrow keys (after 500, 1 000 or 2 000 operating hours).
To switch off the notification, select *No notification*.

When the specified operating hours have been reached, a message appears. Contact your local Eppendorf partner. The contact addresses can be found online at www.eppendorf.com/worldwide.

7.2 Cleaning

Clean the housing of the ThermoStat C and the thermoblocks regularly.



DANGER! Electric shock as a result of penetration of liquid.

- ▶ Switch off the device and disconnect the power plug before starting cleaning or disinfection work.
- ▶ Do not allow any liquids to penetrate the inside of the housing.
- ▶ Use closed tubes and closed plates.
- ▶ Do not spray clean/spray disinfect the housing.
- ▶ Only plug the device back in if it is completely dry, both inside and outside.



NOTICE! Damage from the use of aggressive chemicals.

- ▶ Do not use any aggressive chemicals on the device or its accessories, such as strong and weak bases, strong acids, acetone, formaldehyde, halogenated hydrocarbons or phenol.
- ▶ If the device has been contaminated by aggressive chemicals, immediately clean it by means of a mild cleaning agent.



NOTICE! Corrosion from aggressive cleaning agents and disinfectants.

- ▶ Do not use corrosive cleaning agents, aggressive solvents or abrasive polishes.
 - ▶ Do not use lab cleaners with sodium hypochlorite.
-

Maintenance

Eppendorf ThermoStat C

English (EN)

Auxiliary equipment

- Lint-free cloth
- Mild, soap-based lab cleaner
- Dist. water

Cleaning the ThermoStat C

1. Switch off the ThermoStat C and disconnect it from the power supply.
2. Allow the device to cool down.
3. Clean all of the outer parts of the ThermoStat C with a mild soap solution and a lint-free cloth.
4. Wipe off the soap solution with dist. water.
5. Dry all cleaned parts.

7.2.1 Cleaning the thermoblock

Auxiliary equipment

- Lint-free cloth
- Mild, soap-based lab cleaner
- Dist. water

Clean the thermoblock immediately if sample fluid enters the bore holes or comes into contact with the surfaces.

1. Clean with a mild soap solution.
2. Wipe off the soap solution with dist. water.
3. Dry the cleaned thermoblock.

7.3 Disinfection/Decontamination

**DANGER! Electric shock as a result of penetration of liquid.**

- ▶ Switch off the device and disconnect the power plug before starting cleaning or disinfection work.
- ▶ Do not allow any liquids to penetrate the inside of the housing.
- ▶ Use closed tubes and closed plates.
- ▶ Do not spray clean/spray disinfect the housing.
- ▶ Only plug the device back in if it is completely dry, both inside and outside.

Auxiliary equipment

- Lint-free cloth
 - Disinfectant.
1. Switch the ThermoStat C off and isolate from the power supply.
 2. Allow the device to cool down.

3. Clean the device (see *Cleaning on p. 33*).
4. Select a disinfection method which complies with the legal requirements and regulations applicable to your range of application.
5. Wipe the surfaces with the lint-free cloth and disinfectant.

7.4 Decontamination before shipment

If you are shipping the device to the authorized Technical Service for repairs or to your authorized dealer for disposal please note the following:



WARNING! Risk to health from contaminated device

1. Follow the instructions in the decontamination certificate. You find it as a PDF file on our website (www.eppendorf.com/decontamination).
 2. Decontaminate all the parts you would like to dispatch.
 3. Include the fully completed decontamination certificate in the package.
-

7.5 Verification of temperature control

To verify the temperature accuracy of the thermoblock, use the Eppendorf Temperature Verification System – Single Channel. In combination with the temperature sensor for the ThermoStat C the exact temperature in the thermoblock can be measured.

Details on the verification process with the Eppendorf Temperature Verification System – Single Channel can be found in the corresponding operating manual.

8 Transport, storage and disposal

8.1 Transport



CAUTION! Risk of injury when lifting and carrying heavy loads

The device is heavy. Lifting and carrying the device can lead to back injuries.

- ▶ Only lift and transport the device with a sufficient number of helpers.
- ▶ Use a transport aid for transporting the device.

- ▶ Use the original packaging for transport.

	Air temperature	Relative humidity	Atmospheric pressure
General transport	-25 °C – 60 °C	10 % – 75 %	30 kPa – 106 kPa
Air freight	-40 °C – 55 °C	10 % – 75 %	30 kPa – 106 kPa

8.2 Storage

	Air temperature	Relative humidity	Atmospheric pressure
In transport packaging	-25 °C – 55 °C	10 % – 95 %	70 kPa – 106 kPa
Without transport packaging	-5 °C – 45 °C	10 % – 95 %	70 kPa – 106 kPa

8.3 Disposal

In case the product is to be disposed of, the relevant legal regulations are to be observed.

Information on the disposal of electrical and electronic devices in the European Community:

Within the European Community, the disposal of electrical devices is regulated by national regulations based on EU Directive 2002/96/EC pertaining to waste electrical and electronic equipment (WEEE).

According to these regulations, any devices supplied after August 13, 2005, in the business-to-business sphere, to which this product is assigned, may no longer be disposed of in municipal or domestic waste. To document this, they have been marked with the following identification:



Because disposal regulations may differ from one country to another within the EU, please contact your supplier if necessary.

9 Technical data

9.1 Power supply

Power connection	100 V – 130 V \pm 10 %, 50 Hz – 60 Hz 220 V – 240 V \pm 10 %, 50 Hz – 60 Hz
Power consumption	Maximum 200 W
Overvoltage category	II
Degree of pollution	2
Protection class	I

9.2 Weight/dimensions

Dimensions	Width:	20.6 cm (8.1 in)
	Depth:	30.4 cm (12.0 in)
	Height:	ThermoStat C: 13.6 cm (5.4 in)
Weight	ThermoStat C: 4.4 kg (9.7 lb)	

9.3 Ambient conditions

Ambience	Only for use indoors.
Ambient temperature	5 °C – 40 °C
Relative humidity	10 % – 90 %, non-condensing.
Atmospheric pressure	79.5 kPa – 106 kPa

9.4 Application parameters

9.4.1 Temperature control

Temperature control range	Minimum: 30 °C ±2 °C below ambient temperature Maximum: 100 °C, with SmartBlock 12 mm and SmartBlock <i>cryo</i> 110 °C Temperature setting <i>off</i> , -10 °C – 110 °C, adjustable in steps of 1 °C	
Temperature accuracy	Set temperature 20 °C – 45 °C ±0.5 °C	Set temperature < 20 °C or > 45 °C ±1.0 °C
SmartBlock 1.5 mL	You can find information on the temperature accuracy of other SmartBlocks on the website www.eppendorf.com .	
Temperature homogeneity	In the range of 20 °C – 45 °C max. ±0.5 °C for all positions of the thermoblock	
Heating rate*	5.5 °C/min The change of temperature in filled tubes is slower.	
Cooling rate*	if the set temperature is above ambient temperature if the set temperature is between ambient temperature and 30 °C below ambient temperature	5.0 °C/min 2.0 °C/min

*Heating rate and cooling rate can be throttled (see *Restricting ramp rates on p. 28*).

9.4.2 Time setting

Cycle time	15 s – 99:30 h, unlimited <ul style="list-style-type: none"> • In the range of 15 s – 20 min adjustable in steps of 15 s • In the range of 20 min – 1:00 h adjustable in steps of 1 min • In the range of 1:00 h – 10:00 h adjustable in steps of 5 min • In the range of 10:00 h – 99:30 h adjustable in steps of 30 min
------------	---

9.5 Interface

USB interface	For Eppendorf service only.
---------------	-----------------------------

10 Ordering information



CAUTION! Poor safety due to incorrect accessories and spare parts.

The use of accessories and spare parts other than those recommended by Eppendorf may impair the safety, functioning and precision of the device. Eppendorf cannot be held liable or accept any liability for damage resulting from the use of incorrect or non-recommended accessories and spare parts, or from the improper use of such equipment.

- ▶ Only use accessories and original spare parts recommended by Eppendorf.

10.1 Device and accessories

Order no. (International)	Order no. (North America)	Description
5383 000.019 –	– 5383000027	ThermoStat C basic device without thermoblock 220 V – 240 V 100 V – 130 V
5308 000.003	5308000003	ThermoTop with condens.protect technology with condens.protect technology
5363 000.233	5363000233	Lid for ThermoMixer F0.5/F1.5/F2.0/FP for SmartBlocks 0.5 mL, 1.5 mL, 2.0 mL, plates, PCR 96, PCR 384
5361 000.031	5361000031	SmartBlock 0.5 mL Thermoblock for 24 tubes 0.5 mL
5360 000.038	5360000038	SmartBlock 1.5 mL Thermoblock for 24 tubes 1.5 mL
5362 000.035	5362000035	SmartBlock 2.0 mL Thermoblock for 24 tubes 2.0 mL
5309 000.007	5309000007	SmartBlock 5.0 mL Thermoblock for 8 tubes 5.0 mL
5366 000.021	5366000021	SmartBlock 15 mL Thermoblock for 8 conical tubes 15 mL
5365 000.028	5365000028	SmartBlock 50 mL Thermoblock for 4 conical tubes 50 mL
5364 000.024	5364000024	SmartBlock 12 mm Thermoblock for 24 tubes diameter 11 mm – 11.9 mm, height 34 mm – 76 mm

Order no. (International)	Order no. (North America)	Description
5367 000.025	5367000025	SmartBlock cryo Thermoblock for 24 Cryo tubes 1.5 mL – 2 mL, diameter max. 12,5 mm, all base shapes
5363 000.039	5363000039	SmartBlock plates Thermoblock for microplates and deepwell plates incl. Lid
5306 000.006	5306000006	SmartBlock PCR 96 Thermoblock for PCR plates 96 incl. Lid
5307 000.000	5307000000	SmartBlock PCR 384 Thermoblock for PCR plates 384 incl. Lid

10.2 Tubes and plates

Order no. (International)	Order no. (North America)	Description
0030 121.023	022363611	Eppendorf Safe-Lock Tube 0.5 mL 500 pieces clear
0030 120.086	-	Eppendorf Safe-Lock Tube 1.5 mL 1,000 pieces clear
0030 120.094	-	Eppendorf Safe-Lock Tube 2.0 mL 1,000 pieces clear
0030 124.502	951010057	PCR Tubes 0,5 mL 500 pieces colorless, thin-walled, with hinged lid
0030 124.332 0030 124.200	951010006 -	PCR Tubes 0,2 mL 1,000 pieces PCR clean, colorless clear
0030 124.340	951010014	PCR Tube Strips 0,2 mL, five-tube strip pack of 125 (= 625 tubes) colorless

Order no. (International)	Order no. (North America)	Description
0030 124.359	951010022	PCR Tube Strips 0,2 mL 10 × 12 strips colorless
0030 128.648	951020401	twin.tec PCR Plate 96, skirted low profile, wells colorless, 25 pieces clear
0030 128.575	951020303	twin.tec PCR Plate 96, semi-skirted Wells colorless, 25 pieces standard profile, clear
0030 521.102	951031003	Eppendorf Deepwell Plate 384/200 µL 40 plates, wells clear, white border color PCR clean
0030 501.101	951031801	Eppendorf Deepwell Plate 96/500 µL 40 plates, wells clear, white border color PCR clean
0030 501.209	951032603	Eppendorf Deepwell Plate 96/1000 µL 20 plates, wells clear, white border color PCR clean
0030 501.306	951033405	Eppendorf Deepwell Plate 96/2000 µL 20 plates, wells clear, white border color PCR clean

All plates are available with different border colors (red, yellow, green and blue) and purity qualities, in large packs as well as with barcoding on request. You can find further information in our catalog or on our website www.eppendorf.com.

10.3 Temperature Verification System

Order no. (International)	Order no. (North America)	Description
0056 000.003	0056000003	Temperature Verification System USB – Single channel For Mastercycler nexus, Mastercycler pro und Mastercycler ep, ThermoMixer, ThermoStat
0056 002.006	0056002006	Temperature sensor for Temperature Verification System USB – Single channel 384 Well

11 Program data form

program	time	temp
1		
2		
3		
4		
5		
6		
7		
8		
9		
10		
11		
12		
13		
14		
15		

Index

A

Actual temperature 16
Application parameters 38

C

Cleaning 34
condens.protect 21

D

Danger symbol
 Device 13
Decontamination 35
Deepwell plate 6, 17, 19
Display 7, 16
Disposal 36

G

Glossary 6

H

Hazards 10
Heating/cooling plate 7

I

Installation
 Device 14
 Selecting the location 14
Intended use
 Hazards 10

K

Key lock 26
 Symbol 16

L

Language 26
 Set 17
Lid 6, 19

M

Menu 25
 Menu arrow keys 15
 Navigation 25
 Overview 25
 Setting the language 17
Microplate 6, 17, 19

O

Operating controls 7, 15

P

Pause 23
PCR 6
PCR plate 6, 17, 19
Power connection socket 7
Power switch 7
Program
 Create 27
 Multi-level 28
 Program name 27
 Single-level 27
Program level 16
Program name 16
Program number 16

R

Ramp rates 38
 Restrict 28

S

Safety precautions 10
Selecting the location 14

Set temperature	
Display	16
Speaker	
Set the volume	26
Switch off	26
Symbol	16
Step	28
Storage	36

T

Technical data	
Ambient conditions	37
Application parameters	38
Power supply	37
Weights/dimensions	37
Temperature	
Set	15
Temperature control	
Application parameters	38
Interrupt time counting	15
Interrupting temperature control	23
Set the temperature control duration	15
Setting the temperature control duration	22
Start temperature control	15
Stop temperature control	15
Symbol	16
Temperature control duration	15
Temperature control duration	16
Temperature key	15
Thermoblock	17
Attach	19
Remove	19
ThermoTop	6, 21
Symbol	16
Time mode	
<i>Temp Control</i>	16, 24
<i>Time Control</i>	16, 24
Time setting	15, 22
Application parameters	38
Tubes	17, 19

U

USB interface	7
---------------------	---

V

Verification of temperature control	35
---	----

W

Well	6
------------	---

Declaration of Conformity

The product named below fulfills the requirements of directives and standards listed. In the case of unauthorized modifications to the product or an unintended use this declaration becomes invalid.

Product name:

Eppendorf ThermoStat C

including accessories

Product type:

Thermostat for test tubes and plates

Relevant directives / standards:

2006/95/EC: EN 61010-1, UL 61010-1, CAN/CSA C22.2 No. 61010-1

2004/108/EC: EN 55011, EN 61326-1

2011/65/EU



Management Board

Portfolio Management

Date: December 06, 2013

Your local distributor: www.eppendorf.com/contact
Eppendorf AG · 22331 Hamburg · Germany
eppendorf@eppendorf.com

Eppendorf® and the Eppendorf Logo are registered trademarks of Eppendorf AG Hamburg/Germany.
All rights reserved incl. graphics and pictures. Copyright 2013 © by Eppendorf AG.

ISO 9001
Certified

ISO 13485
Certified

ISO 14001
Certified



Evaluate Your Manual

Give us your feedback.
www.eppendorf.com/manualfeedback

Your local distributor: www.eppendorf.com/contact
Eppendorf AG · 22331 Hamburg · Germany
eppendorf@eppendorf.com · www.eppendorf.com