

High Performance Refrigerated Centrifuge User Manual



C0226R







Read it before use!

CE

Labnet
Labnet International

© 2018 Corning Incorporated

	<p>WARNING!</p> <p>Risk of injury.</p>
	<p>DANGER!</p> <p>Risk of electric shock with potential for severe injury or death as a consequence.</p>
	<p>DANGER!</p> <p>Biohazard with potential for risk to health or death as a consequence.</p>
	<p>DANGER!</p> <p>Risk of explosion with potential for severe injury or death as a consequence.</p>

This manual was prepared with special care. LABNET INTERNATIONAL may change the manual at any time and without notice.
Changes will be incorporated in later editions of user manual.

This manual is designed to assist you in the optimal usage of your Labnet Refrigerated Laboratory Centrifuge. The manual is available in English, French, German, Italian, Portuguese, and Spanish on our website at: www.labnetinternational.com

Contents

1	APPLICATION	6
2	TECHNICAL SPECIFICATION	7
3	INSTALLATION	8
3.1	CONTENT OF PACKAGE	8
3.2	LOCATION	8
3.3	CURRENT PROTECTION	9
4	SAFETY OF OPERATION	10
4.1	OPERATING PERSONNEL	10
4.2	GUARANTEE	10
4.3	ARRANGEMENT OF TUBES	10
4.4	SAFETY HINTS	11
4.5	MAINTENANCE CONDITIONS	12
4.6	SAFETY PRECAUTIONS	13
4.7	RESIDUAL RISK	14
5	OPERATING	15
5.1.	CENTRIFUGE DESCRIPTION	15
5.2.	CENTRIFUGE OVERVIEW	15
5.3	CONSTRUCTION	16
5.4	NAME PLATE	16
5.5	ROTOR AND ACCESSORIES INSTALLATION	16
5.6	CONTROL DEVICE	18
5.7	SETTING PARAMETERS	18
5.8	SAFETY FEATURES	18
6	CENTRIFUGATION	19
6.1	CONTROL PANEL	19
6.2	DISPLAY	20
6.3	SETTING UP RPM, RCF, TIME, TEMPERATURE	22
6.4	USERS PROGRAMS	24
6.5	ROTOR CHOOSING	26
6.6	SHORT MODE	27
6.7	FINISHING THE CENTRIFUGING	28
7	TEMPERATURE CONTROL	29
7.1	INITIAL COOLING DURING CENTRIFUGING - FAST COOL	29
7.2	INITIAL COOLING WITHOUT CENTRIFUGING – THERMAL CHAMBER	30
7.3	COOLING IN “START DELAY – OF TEMPERATURE” MODE	30
7.4	COOLING IN „SHORT” MODE	31
7.5	COOLING NOTES	31
8	PARAMETERS OF CENTRIFUGATION	32

8.1	ACCELERATION/DECELERATION – CHARACTERISTICS CHOOSING	33
8.2	RADIUS	33
8.3	DENSITY	33
8.4	TEMPERATURE OFFSET	34
8.5	THERMAL CHAMBER DELAY	35
8.6	THERMAL CHAMBER (CONSTANT TEMPERATURE IN CHAMBER WITHOUT CENTRIFUGING)	35
8.7	AUTOMATIC LID OPEN	36
8.8	START DELAY - OF TIME	36
8.9	START DELAY – OF TEMPERATURE.....	37
8.10	SCREEN MESSAGES	38
8.11	UNBALANCE	41
9	MENU	42
9.1	SCREEN SAVER	43
9.2	VISUAL ALARM	43
9.3	TYPES OF MAIN SCREEN	43
9.4	ROTATING TIME.....	45
9.5	BUZZER	46
9.6	DATE/TIME	47
9.7	LANGUAGE.....	47
9.8	OTHER	47
9.9	PASSWORD PROTECTION.....	48
9.10	CYCLES HISTORY	49
9.11	TOTAL WORK TIME	49
9.12	ROTOR CYCLES	50
9.13	DIAGNOSTICS.....	50
9.14	FACTORY SETTINGS.....	50
9.15	MANUFACTURER’S DETAILS	51
10	MAINTENANCE	52
10.1	CLEANING OF THE CENTRIFUGE.....	52
10.2	MAINTENANCE OF CENTRIFUGE ELEMENTS	52
10.3	STERILIZATION	54
10.4	CHEMICAL RESISTANCE	56
11	TROUBLESHOOTING.....	57
12	LIMITED WARRANTY.....	59
13	DISPOSAL.....	60
14	MANUFACTURER’S INFO.....	61
15	ANNEXES.....	62

1 Application

The Labnet C0226R centrifuge is a high performance refrigerated table top laboratory centrifuge. This device is used for separation samples taken from people, animal and plant components of different densities, under the influence of the centrifugal force, to provide information about their biological.

Its construction ensures easy operation, safe work and wide range of applications at laboratories engaged in routine medical analyses, biochemical research works etc.

This centrifuge is not biotite and therefore during centrifugation of preparations requiring bio tightness one must use bio tightness certificated containers and rotors. It is prohibited to centrifuge caustic, inflammable and explosive preparations.

2 Technical specification

Manufacturer	Corning Incorporated 271 County Route 64, Big Flats, NY 14814	
Type	Labnet – C0226R	
Mains voltage (L1+N+PE)	230V ±10%	120V ±5%
Frequency, ±1%	50 Hz	60Hz
Power consumption (max)	500W	500W
Current protection	T 6,3A	T 10A
Cooling medium	R507 (CFC/HCFC free) = 0,14 kg	
t eq CO ₂	0,558	
GWP	3985	
Capacity (max)	90ml (6x15ml)	
Speed (rpm)	90 ÷ 15000 rpm (step 1 rpm)	
G-force (RCF)	21382 x g (step 1 x g)	
Running time	00:00:01 ÷ 99:59:59 – [h. : min : s] (1s step)	
Time counting	since start button is pressed / since preselected speed is reached	
Short time operation mode (SHORT)	yes	
Continuous operation mode (HOLD)	yes	
Number of programs	100	
Adjustable temperature	-20 ÷ 40°C* (step 1°C)	
Initial cooling (FASTCOOL)	yes	
Guaranteed temperature with max. rotor speed	≤4°C	
Cooling without centrifuging	yes	
Acceleration (ACEL)	10 linear characteristics	
Deceleration (DECEL)	10 linear characteristics	
USB communication	yes	
Electromagnetic compatibility	accordance with EN 61326-2-6:2006	
Ambient conditions	PN-EN 61010-1 (pkt.1.4.1)	
Set-up site	indoor only	
Ambient temperature	2° ÷ 40°C	
Humidity (maximum relative humidity)	< 80%	
Installation category	II	EN 61010-1
Pollution degree	2	EN 61010-1
Safety area	300 mm	
Degree of protection: (according to PN-IEC 34-5)	IP20	
Noise level	≤60dB	
Weight	30,5 kg	33kg
Dimensions:		
height (H)	285 mm	
width (W)	299 mm	
depth (D)	595 mm	
Height with open lid (H _{oc})	565 mm	

*time and possibility of obtaining a set temperature is dependent on multiple factors, including: rotor type, established RPM, ambient temperature; accuracy: - ±1°C appropriate for place of temperature sensor

Menu languages: English, Spanish, Italian, Portuguese, German, Russian, Polish, Swedish, French, Czech.

3 Installation

Open the package. Take out the box containing the accessories. Take out centrifuge from the container. Keep the box and packing materials in case of service shipping.

3.1 Content of package

name	pcs
Centrifuge Labnet C0226R	1
Complete clamp	1
Spanner for a rotor	1
Key for emergency lock release	1
Power cord 120V / power cord 230V	1
Fuse WTA T10 250V / WTA T6,3 250V	2
Petroleum jelly 20ml	1
USB A-A cable	1
user manual	1

3.2 Location

	<ul style="list-style-type: none"> ▪ The device is heavy, so lifting and carrying the centrifuge can lead to back injuries. Risk of injury while lifting and carrying heavy loads. ▪ Lifting and transporting of the centrifuge should be done with a sufficient number of helpers. Use a transport aid for transporting the centrifuge. ▪ The device should be lifted by the underside in the vicinity of the its feet and placed directly on a suitable lab table.
	<ul style="list-style-type: none"> ▪ Ensure safe location. ▪ The centrifuge shall not be located near source of heat and shall not be subjected to direct sunlight. ▪ Centrifuge should be flat-levelled. Effect of leveling shall be ensure by stable and flat-levelled table top for the centrifuge. ▪ Centrifuge should be set horizontally on a rigid base. ▪ It is necessary to ensure a ventilation zone of the minimum 30cm round the centrifuge from every direction. Do not veil ventilation holes ! ▪ Table for centrifuge should posses safety zone of the minimum 30cm round the centrifuge from every direction (safety needs in case of malfunction according to EN 61010-020). ▪ Table for centrifuge should be free of containtments before locating of centrifuge. ▪ Passed parameters of the centrifuge are referring to the above named temperatures (see 2.Technical specification). ▪ At the change of the place from cold to warm one, condensation of water will occur inside the centrifuge. It is important then that sufficient time be provided for drying the centrifuge prior to starting the centrifuge again (min. 4 hours).

	<ul style="list-style-type: none"> ▪ Do not position the centrifuge so that it is difficult to operate the power switch ▪ Supply voltage given on the rating plate has to be consistent with local supply voltage. LABNET INTERNATIONAL laboratory centrifuges are 1st safety class devices and they are provided with the three-core cable with the plug resistant to dynamic loadings. Mains socket shall be provided with the safety pin - protective earth (PE). ▪ It is recommended to install emergency cut-out that shall be located far from the centrifuge, near the exit or beyond the room.
---	---

	<ul style="list-style-type: none"> ▪ Before switching on, check whether the centrifuge is connected to power supply correctly. ▪ Before using check whether the device is correctly installed.
---	--

3.3 Current protection

	<p>The centrifuge is equipped with current protection (safety fuse). Fuse is situated in the plug-in socket unit at back wall of the centrifuge.</p>
---	--

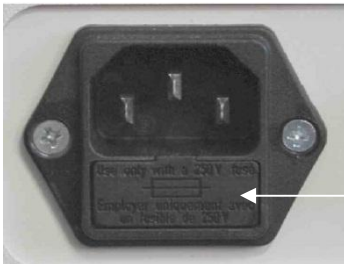

Safety fuse

Fig.1 Plug-in socket unit

4 Safety of operation



4.1 Operating personnel

	<ul style="list-style-type: none">▪ Laboratory centrifuge can be operated by laboratory personnel after getting acquainted with user manual.▪ User manual shall be always held near the centrifuge.▪ The centrifuge can not be misused.▪ If the centrifuge is used in a manner not specified by the manufacturer, the protection provided by the device may be impaired.
---	---

4.2 Guarantee

	<ul style="list-style-type: none">▪ Guarantee period amounts to 24 months (unless otherwise specified in the purchase documents).▪ The service life of the centrifuge specified by the manufacturer amounts to 10 years.▪ After termination of guarantee period it is necessary to carry out yearly technical inspections of the centrifuge.▪ Manufacturer reserves the right to make technical changes in manufactured products.▪ Maximum period of storage of unused centrifuge amounts to 1 year. After this period, a service authorized by manufacturer should carry out technical inspection of the centrifuge.
---	---

4.3 Arrangement of tubes

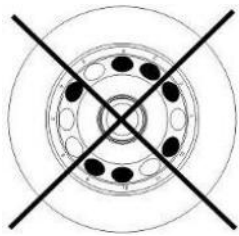
	<ul style="list-style-type: none">▪ Fix the rotor on the motor axis firmly.▪ Avoid unbalance.▪ Load opposite buckets with the same accessories.▪ Centrifugation of the test tubes of different sizes:<ul style="list-style-type: none">▪ There is a possibility to centrifuge test tubes of different sizes; however, it is absolutely necessary in such cases that opposite buckets and round carriers be the same.▪ Mass of different containers with test tubes spun at the same time has to be comparable.
 CORRECT	 INCORRECT
It is necessary to insert test tubes symmetrically on the opposite sides.	

	<p>FILLING TUBES</p> <ul style="list-style-type: none"> ▪ Fill test tubes outside the centrifuge and according to the manufacturer's recommendations. ▪ Please pay special attention to the quality and proper thickness of the glass test tubes walls. Those shall be test tubes for centrifuges. ▪ In order to protect the centrifuge against unbalance, fill in the test tubes up to the same weight.
---	--

4.4 Safety Precautions

	<p>ROTOR MAINTENANCE</p> <ul style="list-style-type: none"> ▪ Lubricate the swing-out rotor journal pins. ▪ Use only accessories in good condition. ▪ Protect equipment against corrosion using accurate preventive maintenance.
---	--

	<p>HS ACCESSORIES MAINTENANCE</p> <ul style="list-style-type: none"> ▪ Make sure that rubber O-rings are lightly coated with petroleum jelly (to ensure vacuum), use high vacuum grease.
---	--

	<p>HAZARDOUS MATERIALS</p> <ul style="list-style-type: none"> ▪ LABNET accessories are not biotight. For centrifuging infectious materials it is necessary to use hermetically closed tubes meeting demands of biotightness, in order to prevent germs migration into the centrifuge and beyond it. ▪ NEVER subject to centrifugation toxic materials with damaged leak proof seals of the rotor or test-tube. Proper disinfection procedures have to be carried out when dangerous substances contaminated the centrifuge or its accessories.
---	---

	<p>EXPLOSIVE AND COMBUSTIBLE MATERIALS</p> <ul style="list-style-type: none"> ▪ It is not allowed to centrifuge explosive and inflammable materials. ▪ NEVER centrifuge substances prone to react as a result of supplying high energy during centrifugation. ▪ The centrifuge can not be operated in explosion-endangered areas. ▪ NEVER centrifuge materials capable of generating inflammable or explosive mixtures when subjected to air.
---	--

4.5 Maintenance conditions

	<p>START-UP</p> <ul style="list-style-type: none">▪ Prior to switching the centrifuge on, one shall read carefully all sections of this instruction in order to ensure smooth operation and avoid damages of this device or its accessories.▪ In order to protect the centrifuge against unbalance, fill in the test tubes up to the same weight.
---	---



	<p>TRANSPORTATION</p> <ul style="list-style-type: none">▪ Centrifuge must not be transported with the rotor mounted on the shaft.
---	--

	<p>GENERAL HINTS</p> <ul style="list-style-type: none">▪ One must use original rotors, test-tubes and spare parts only.▪ In case of faulty operation of the centrifuge one shall ask for assistance service of LABNET INTERNATIONAL/Corning or its authorized representatives.▪ NEVER switch the centrifuge on if it is not installed properly or rotor is not fitted correctly.
---	---

	<p>CENTRIFUGING SUBSTANCES</p> <p>NEVER exceed load limit set by the manufacturer. Rotors are intended for fluids of average homogeneous density equal to 1,2 g/cm³ or smaller when centrifugation is carried out at maximum speed. When fluids of higher density shall be used, then it is necessary to change density of centrifuges sample in PARA/DENSITY field.</p>
---	--

4.6 Safety precautions

For safety reasons, inspections of the centrifuge carried out by the authorized service at least once a year after the period of warranty. The reason for more frequent inspections could be corrosion inducing environment. Examinations should end with issuing report of validation that checks on the technical state of the laboratory centrifuge. It is being recommended to establish document where every repairs and reviews are being registered. Both these documents should be stored in the place of use of the centrifuge.

	<p align="center">INSPECTION PROCEDURES CARRIED OUT BY THE OPERATOR</p>
	<p>Operator has to pay special attention to the fact that the centrifuge parts of key importance due to safety reasons are not damaged. This remark is specifically important as for:</p> <ul style="list-style-type: none"> ▪ Centrifuge accessories and especially structural changes, corrosion, preliminary cracks, abrasion of metal parts. ▪ Screw connections. ▪ Inspection of bioseals of the buckets if such are used. Special attention must be paid to all of the rubber (seals) parts. In the case of damage or visible structural changes defective parts must be replaced for new immediately ▪ Control of execution of the guarantee yearly technical inspection of the centrifuge (after lapse of guarantee). <p>Only the manufacturer specified buckets, included in the equipment list, as well as centrifuge tubes, which diameter, length and durability are suitable, should be used for spinning in this centrifuge.</p> <p>The use of equipment made by other manufacturers should be consulted with the manufacturer of the centrifuge.</p> <ul style="list-style-type: none"> ▪ NEVER lift or shift the centrifuge during operation, and rest on it. ▪ It is not allowed to stay in the safety zone within 30 cm distance around the centrifuge neither leave within this zone some things, e.g. glass vessels. ▪ NEVER put any objects on the centrifuge.
	<p align="center">LID OPENING</p>
	<p>NEVER open the cover manually in emergency procedure when rotor is still turning because it may cause loss of health or life.</p>

	ROTORS
	<ul style="list-style-type: none"> ▪ NEVER use the rotors and round carriers with signs of corrosion or other mechanical defects. ▪ NEVER centrifuge highly corrosive substances which may cause material impairment and lower mechanical properties of rotor and round carriers. ▪ NEVER use rotors and accessories specified by the manufacturer. You must use commercial glass and plastic test tubes, which are destined to centrifuging in this laboratory centrifuge. One should absolutely not use poor quality elements. Cracking of glass vessels and test tubes could result in dangerous vibration of the centrifuge. ▪ NEVER carry out centrifugation with the rotor caps taken off or not driven tight.

4.7 *Residual risk*

The centrifuge is built according to the state-of-the-art and the recognized safety regulations. Nevertheless, there remains some level of residual risk due to improper operation and malfunctions. It is possible to decrease residual risk by strictly applying user manual conditions and correcting malfunction which could threaten safety, immediately.

5 Operating

5.1. Centrifuge description

New generation of LABNET INTERNATIONAL laboratory centrifuges is provided with state-of-the-art microprocessor control systems, very durable and quiet asynchronous brushless motors and accessories consistent with requirements of the present-day user.

5.2. Centrifuge overview



- 1. Power switch
- 2. USB
- 3. Control panel
- 4. Point of emergency lid opening
- 5. Lid
- 6. Inspection glass

Fig.2. Left side of centrifuge

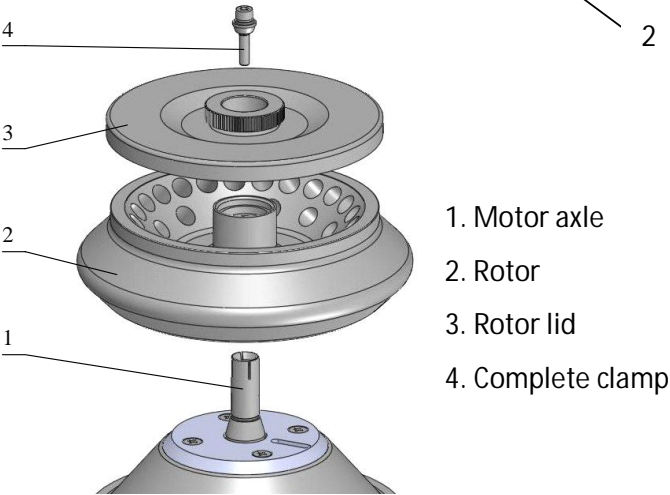
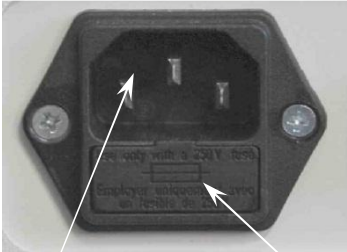

Fig.3. Assembly of angle rotor

Fig.4. Mains socket back of the centrifuge









- 1. Plug-in socket
- 2. Fuse socket

5.3 Construction

The centrifuge has a rigid self-supporting structure. Housing is made of sheet aluminium, back made of steel sheet. Front and cover was made of ABS. Cover is fixed on steel axles of hinges and from the front it is locked with electric lock blocking possible opening during centrifugation. The rotation chamber bowl is made of stainless steel sheet.

5.4 Name plate

Labnet  **REF** C0226R
High Performance Refrigerated Centrifuge
Rating: 120V~60Hz, 500W \Rightarrow T 10A
n: 15000 RPM R507: 0,16kg CFC FREE
SN 10150R010018
LOT 11318003 
WWW.LABNETINTERNATIONAL.COM
 2018-04-23 Made in POL

Labnet  **REF** C0226R-230V
High Performance Refrigerated Centrifuge
Rating: 230V~50Hz, 500W \Rightarrow T 6,3A
n: 15000 RPM R507: 0,16kg CFC FREE
SN 10150R010018
LOT 11318003   
WWW.LABNETINTERNATIONAL.COM
 2018-04-23 Made in POL

5.5 Rotor and accessories installation

- Connect the centrifuge to the mains (master switch on the back side of the centrifuge).
- Turn on the centrifuge (button on the side of the centrifuge).
- Open the lid of the centrifuge by pressing the COVER key (see section Centrifuging / Control Panel). Prior to putting the rotor in, one has to check if the rotating chamber is free of impurities, e.g. such as dust, glass splinters, residues of fluids that must be taken away.
- One shall fit the rotor on the motor shaft driving it home on the cone.
- Screw-in the bolt for fixing the rotor (clockwise) and screw it tightly home with the supplied spanner for the rotor.

- In case of rotors designed with the cover they must not be used without it. Rotor covers must be closed exactly. Rotor covers ensure smaller drags of the rotors, proper setting of the test-tubes and airtight sealing.
- One should use only buckets intended for selected types of the rotor.
- Fill test tubes outside the centrifuge.
- In case of centrifuging in an angle rotor, test tubes (buckets) have to be filled properly in order to prevent from pouring fluids during centrifuging.

Tubes must be filled so that the material does not escape from the reservoir during centrifugation.

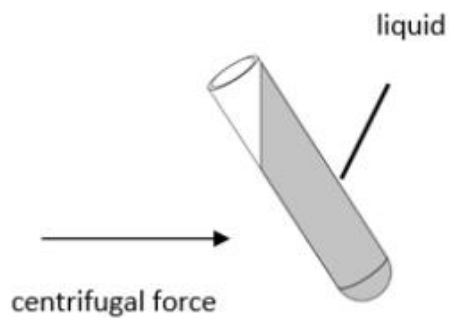

One shall fill tubes according to formula:

$$\text{Max liquid level} < \text{Tube height} - \text{Internal tube diameter}/2$$

Internal tube diameter

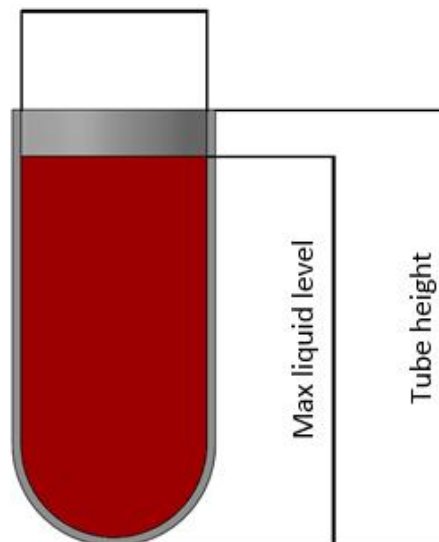

Observe the manufacturer's restrictions about the filling of the test tube.



It is recommended to equalize vessels loads, as much as possible in order to ensure minimal vibrations during operation.

- In order to prolong lifetime of the rotor and gaskets rotors shall be lubricated with the maintenance oil, while gaskets and threaded parts shall be lubricated with the petroleum jelly.
- For replacement of the rotor one shall unscrew clamping and then grab the rotor with both hands at opposite sides, taking it away from drive shaft by pulling it up.

5.6 *Control device*

The microprocessor control unit of the centrifuge ensures broad possibilities of providing, realisation and reading of work parameters.

5.7 *Setting parameters*

Data setting and read-out system forms hermetically closed keyboard with distinctly accessible operation points. Easily readable displays signaling individual performed operations facilitate operator's programming and recording of parameters and condition of the centrifuge. The centrifuge is provided with the USB interface that enables connection of the centrifuge to external PC unit with the printer and recording the centrifugation parameters.

5.8 *Safety features*

Cover lock

The centrifuge can be started only with properly closed cover, while the cover can be opened only after stopping the rotor. In case of emergency opening of the cover during operation, the centrifuge will be immediately switched-off and the rotor will brake till complete stopping. During cover closing it is prohibited to press any buttons. Do not place fingers into closing area during cover closing.

Unbalance detecting

When loads of opposite buckets or carriers in rotors are unbalanced, the drive will be switched-off during acceleration or operation of the centrifuge – and the error message will be displayed.

Rotor verification and checking compatibility with set program

Directly after starting centrifuging, a unit verifies the type of the rotor applied and in the case of its incompatibility with the type indicated in the application or absence of the rotor, the spinning process shall be stopped with simultaneous displaying the error message. The conformity of the type of the rotor is signalled with a single audible signal. In case auto identification (see 9.8 Other) option is checked, proper rotor will be automatically chosen, without user engagement.

Rest state inspection

Opening of the centrifuge's cover is possible only with the rotor in the state of rest. When the rotor is being stopped, the STOP diode is on and goes off when it is stopped. (except emergency cover opening) – see p. TROUBLESHOOTING.

Checking of excessive temperature

If temperature in rotation chamber exceeds 50°C caused by, for example, malfunction of cooling system, drive will be switched off and error message will be displayed. The reboot is only possible after chilling device.

6 Centrifugation

Power switching ON/OFF is carried out with master switch situated on the right-side wall of the centrifuge. All settings on the centrifuge are done by means of the control panel.

6.1 Control panel

The control panel placed on the front casing serves the purpose of controlling centrifuge operation.



Control panel



	SHORT ¹	short-time centrifuging
	START	start centrifugation run
	STOP ²	end centrifugation run
	COVER	cover opening
	FAST COOL	start fast cooling mode
	BACK RPM/RCF	exit the current menu / cancelling switching between rpm display mode and rcf display mode
	UP	navigation in menu / increasing values
	DOWN	navigation in menu / decreasing values
	LEFT	navigation in menu
	RIGHT	navigation in menu
SET	SET	changing parameters / confirming changes

¹ the centrifuge is working as long as the key is pressed

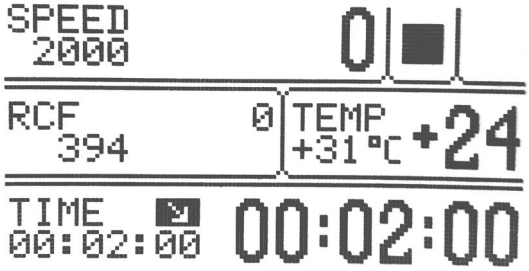

² First-time pressing will make stopping centrifuging with acceleration characteristics set in the current program; second-time pressing will make braking as fast as possible.

6.2 Display

The display is located in the centre of the control panel. The main screen variants are presented below.



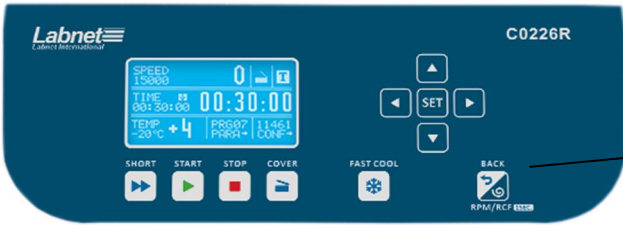

















	<p>After switching on centrifuge, welcome screen appears. After the welcome screen disappears it is possible to setting up parameters.</p>
	<p>Simplified display mode is set as default, there is possible to switch to normal (see chapter 9.3) display mode (with two sub modes shown below).</p>
<p>Normal display</p>	
<p>RPM display mode</p>	<p>RCF display mode</p>
	

Switching between RPM and RCF display mode

	<p>For normal display switching between RPM and RCF display mode may be obtain by pressing and keeping key by 1s :</p>  <p>then one should choose demand mode.</p>
---	---

SPEED	rotor speed	assigned/measured
RCF	centrifugal force	assigned/measured
TIME	centrifuging time	assigned/measured
TEMP	temperature	assigned/measured
PRG	program no.	
11944	rotor no.	
PARA	parameters of the centrifuge	
MENU	configuration menu	

Display Symbols



	changing values		
	density > 1,2 g/cm ³		
	centrifuging radius changed		
	counting time down (decreasing)		counting time up (increasing)
	centrifuging		centrifuging (with automatic cover opening)
	rotor stopped / closed cover		rotor stopped / opened lid
	braking		fastest decelerating
	rotor identification		
	thermal chamber		
	temperature delay		
	time delay		
	currently enlarged digits of TIME field		
	drop-down list		
	temporarily disabled		
	locked		
	time counting (blinking)		
	disabled option		

6.3 Setting up RPM, RCF, time, temperature



On the main screen, it is possible to set:

rotating speed - RPM	SPEED
relative centrifugal force (multiple of g-force)	RCF
centrifuging time	TIME
centrifuging temperature	TEMP

Exemplary change of SPEED setting:

	<ul style="list-style-type: none"> ▪ Press SET (to enter edit mode) –  appears. ▪ Via ▲▼◀▶ keys mark SPEED field (highlighted). ▪ Press SET- blinking. ▪ With ▲▼ choose demanded value. ▪ Via ◀▶ choose order of magnitude of changing value (highlighted). ▪ Repeat above two steps for other orders of magnitude. ▪ Confirm settings by pressing SET. ▪ Press BACK.
<p>When RPM is changed, RCF is automatically corrected.</p>	

Exemplary change of RCF setting:

	<ul style="list-style-type: none"> ▪ Press SET (to enter edit mode) –  appears. ▪ Via ▲▼◀▶ keys mark RCF field (highlighted). ▪ Press SET- blinking. ▪ With ▲▼ choose demanded value. ▪ Via ◀▶ choose order of magnitude of changing value (highlighted). ▪ Repeat above two steps for other orders of magnitude. ▪ Confirm settings by pressing SET. ▪ Press BACK.
<p>When RCF is changed, RPM is automatically corrected.</p>	

Switching between SPEED and RCF.



On the screen appear an additional window, in which:

- Via ▲▼ keys mark field .
- Press SET.

Change of screen mode will be active to switch off the centrifuge

Switching between basic and simplified screens is described in 9.3 Main screen modes.

Exemplary change of TIME setting:



- Press SET (to enter edit mode) -  appears.
- Via ▲▼◀▶ keys mark TIME field (highlighted).

00:02:00
[hh : mm : ss]

e.g.:
centrifuging time – 2 minutes 00 seconds

- Press SET -  blinking.
- With ▲▼ choose demanded value.
- Via ◀▶ choose order of magnitude of changing value (highlighted).
- Repeat above two steps for other orders of magnitude.
- Confirm settings by pressing SET.
- Exit edit mode by pressing BACK.

00:02:00

set value

02:00

current value (most significant digits)

HOLD mode	continuous run mode
	<ul style="list-style-type: none"> To run centrifuging in HOLD mode set 00:00:00 time. To end centrifuging in HOLD mode press STOP.

Exemplary change of TEMP setting:	
	<ul style="list-style-type: none"> Press SET (to enter edit mode) - appears. Via ▲▼◀▶ keys mark TEMP field (highlighted). Press SET key. With ▲▼ choose demanded value. Confirm settings by pressing SET. Press BACK.

6.4 Users programs

	<p>After switching centrifuge on, program that was used in previous session is being loaded. If any program was not used in previous session, centrifuge resume the last chosen parameters.</p>
--	---

Program choosing:	
Simplified display mode	
	<ul style="list-style-type: none"> Press and hold by 1 second. Choose PROG with ▲▼ Press SET. Execute points described follow (below Normal display mode description)

Normal display mode



- Press SET key – [PRG-] appears.
- Via ▲▼◀▶ keys mark PRG- – field (highlighted)
- Press SET key – list of programs is visible.

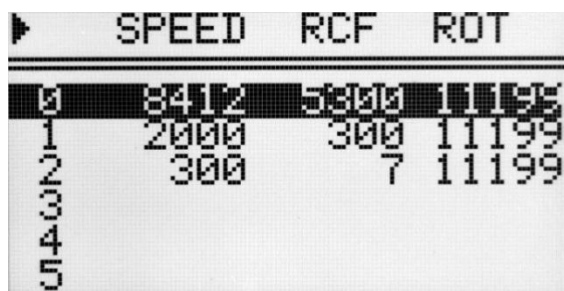

- Via ▲▼ choose demanded program.
- Confirm with SET key.

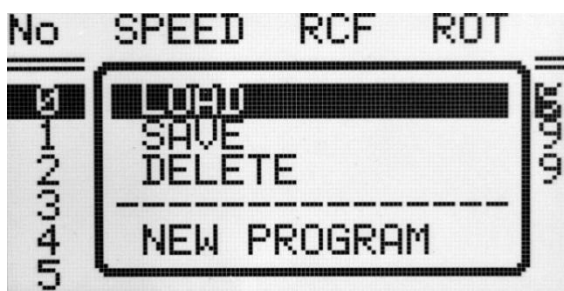

LOAD, SAVE, DELETE, NEW PROGRAM refer chosen program which is highlighted.

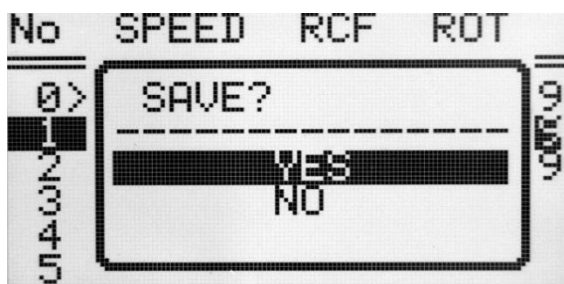

SAVE – save settings as a program (confirm by selecting YES and pressing SET)

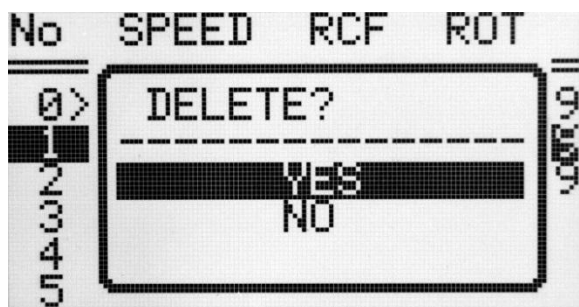

DELETE – delete program (confirm by selecting YES and pressing SET)

NEW PROGRAM– enter to create new program mode (as below)

Creating a new program:

	<ul style="list-style-type: none"> Press SET key. Via ▲▼◀▶ keys mark PRG field (highlighted.) Press SET key. List of programs is visible. Press SET key- menu of program settings will appear. Choose NEW PROGRAM, and then press demanded parameters of centrifuging (look chapter 6. Centrifugation). 																											
<table border="1"> <thead> <tr> <th>No</th> <th>SPEED</th> <th>RCF</th> <th>ROT</th> </tr> </thead> <tbody> <tr> <td>0</td> <td>8412</td> <td>5800</td> <td>11199</td> </tr> <tr> <td>1</td> <td>2000</td> <td>300</td> <td>11199</td> </tr> <tr> <td>2</td> <td>300</td> <td>7</td> <td>11199</td> </tr> <tr> <td>3</td> <td></td> <td></td> <td></td> </tr> <tr> <td>4</td> <td></td> <td></td> <td></td> </tr> <tr> <td>5</td> <td></td> <td></td> <td></td> </tr> </tbody> </table>		No	SPEED	RCF	ROT	0	8412	5800	11199	1	2000	300	11199	2	300	7	11199	3				4				5		
No	SPEED	RCF	ROT																									
0	8412	5800	11199																									
1	2000	300	11199																									
2	300	7	11199																									
3																												
4																												
5																												

Changing parameters during centrifuging

There is a possibility to change parameters: SPEED, RCF, TIME, TEMP during centrifuging. Such modifications inactivate currently running program. Modification during run is represented by PRG -- symbol (instead of the program number).

6.5 Rotor choosing

Rotor choosing	
Simplified display mode	
	<ul style="list-style-type: none"> Press and hold  by 1 second. Choose rotor number (exemplary 11199/-----) with ▲▼. Press SET. Execute points described follow (below Normal display mode description)

Normal display mode



- Press SET-  appears.
- Via ▲▼◀▶ mark rotor choosing field.
Press SET (Rotor list will appear).

ROTOR	BUCKET	SPEED
11461	-----	15000
11716	-----	15000
11760	-----	14000
11942	-----	6000
11943	-----	15000

- Via ▲▼ keys mark demanded rotor number
- Confirm by press SET.
- Press BACK.

RCF	RMAX	RMIN
16854	67	40
20879	83	40
17608	70	40
20160	92	40
3542	88	50
21382	85	51

- With ◀▶ keys one may switch between screens of rotors parameters





It is possible to set AUTOMATIC ROTOR IDENTIFICATION.

The procedure is described in subsection 9.8.

6.6 SHORT mode

SHORT MODE	
	<p>The SHORT mode is activated by pressing and holding ▶▶(SHORT).</p> <p>In SHORT mode the centrifuge is working as long as the SHORT key is pressed or when set time is over.</p>





6.7 Finishing the centrifuging

ENDING CENTRIFUGING	
	When preselected time is reached, centrifugation will end automatically.
	<p>Before lapse preselected time one may stop centrifugation. Pressing STOP for the first time will stop centrifuging with the characteristic set in loaded program. Confirm message by pressing any key (except COVER). </p>
	<p>Pressing STOP second time will stop centrifuging with the fastest characteristic. </p>
<p>The message can be extinguished with the STOP, SET, COVER, ▲▼◀▶ or BACK key.</p>	

7 Temperature control





Centrifuge is equipped with ecological refrigerating system with temperature control. During centrifugation, there may appear differences in temperature on the display and temperature of the samples in the rotor. It depends on thermal conductivity of the rotor, and samples, centrifugation time, initial temperature of rotor and samples

Exemplary change of TEMP setting:

	<ul style="list-style-type: none"> ▪ Press SET (to enter edit mode) –  appears. ▪ Via ▲▼◀▶ keys mark TEMP field (highlighted). ▪ Press SET. ▪ Via ▲▼ set value. ▪ Confirm via SET key.
	<p>When chamber is being cooled,  symbol is visible on the screen (blinking).</p>

7.1 Initial cooling during centrifuging - FAST COOL

	<ul style="list-style-type: none"> ▪ The parameters allowable to change at FAST COOL mode: <ul style="list-style-type: none"> ▪ temperature (lower than current temperature shown by centrifuge) ▪ In order to centrifuge reduced temperature samples (eg. storage in the external refrigerator) centrifuge chamber, rotor and centrifuge container must be pre-cooled to the predetermined temperature. It will cause minimalization of temperature differences. ▪ Initial cooling may be activated by FAST COOL key (lid must be closed – rotor is spinning at FAST COOL mode) ▪ When FAST COOL mode is active, cooling system automatically sets proper parameters to obtain demanded temperature the fastest way. ▪ It is possible to exit FAST COOL mode at any time by pressing STOP key.
---	--

	<p>FAST COOL mode is marked by symbol  blinking in the right upper side of display.</p>
	<p>ATTENTION -to use FASTCOOL mode set temperature must be lower than current temperature shown by centrifuge. When set temperature is higher, ! symbol is visible and acoustic signal is emitted.</p>
	<p>It is possible to exit FAST COOL mode at any time by pressing STOP key. Interruption of the function is signaled by a message.</p>

7.2 Initial cooling without centrifuging – THERMAL CHAMBER

	<p>PARAMETER → THERMAL CHAMBER</p>
	<ul style="list-style-type: none"> There is a possibility of cooling chamber without centrifuging. Way of activate THERMAL CHAMBER is described in chapter "Parameters of centrifugation/Thermal chamber".

7.3 Cooling in "START DELAY – OF TEMPERATURE" mode

	<p>PARAMETER → START DELAY/OF TEMPERATURE</p>
	<p>Centrifuging with set parameters process will start, when preselected temperature is reached. How to enable run START DELAY – OF TEMPERATURE function is described in Parameters of centrifugation chapter.</p>

7.4 Cooling in „SHORT“ mode

	<p>Cooling feature is available in SHORT mode. How to enable run centrifugation in SHORT mode is described in Centrifugation/SHORT mode.</p>
---	--

7.5 Cooling notes

Labnet 226R centrifuge is equipped with an efficient cooling system. It allows obtaining selected temperatures in the chamber even at maximum spin speed or fast obtaining desired temperatures (e.g. 4°C). Note that time and possibility of obtaining a set temperature is dependent on multiple factors, including: the power of the cooling system, the shape of the rotor, the rotor speed, ambient temperature, etc. The accuracy of the temperature stability of $\pm 1^\circ\text{C}$ is determined by the installation place of the temperature sensor.

8 Parameters of centrifugation

Simplified display mode	
	<ul style="list-style-type: none"> Press and hold by 1 second. Choose PARAM with ▲ ▼ Press SET. <p>Execute points described follow (below Normal display mode description)</p>
Normal display mode	
	<ul style="list-style-type: none"> Press SET- appears. With ▲ ▼ ◀ ▶ keys mark PARA field Press SET.

It is possible to switch between two different screens via ▲ ▼ ◀ ▶ keys in PARA field

--	--





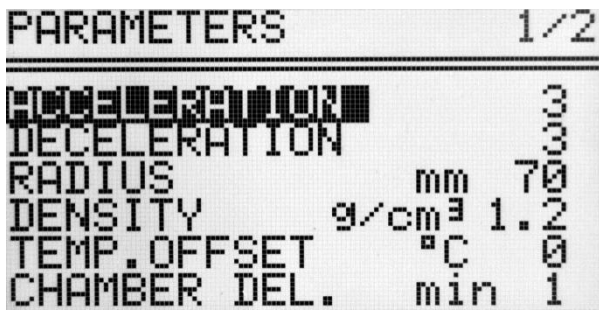

ACCELERATION	chosen acc. characteristic (0-the fastest, 9-the slowest)
DECELERATION	chosen dec. characteristic (0-the fastest, 9-the slowest)
RADIUS [mm]	current rotor radius [mm]
DENSITY (g/cm ³)	sample density [g/cm ³]
TEMP. OFFSET (°C)	value of temperature correction
CHAMBER DEL. (min)	delay between set thermal chamber mode and start it

THERMAL CHAMBER	cooling of the chamber without centrifuging
AUTOM. LID OPENING	opening cover after centrifuging automatically
START DELAY	starting delayed (after pressing START)



8.1 Acceleration/deceleration – characteristics choosing

 <pre> PARAMETERS 1/2 ----- ACCELERATION 3 DECELERATION 3 RADIUS mm 70 DENSITY g/cm³ 1.2 TEMP.OFFSET °C 0 CHAMBER DEL. min 1 </pre>	<p>ACCELERATION – linear accelerating characteristics assigned to every rotor (0 - 9)</p> <p>DECELERATION – linear decelerating characteristics assigned to every rotor (0 - 9).</p> <p>0-the fastest possible acceleration/deceleration, 9-the slowest possible acceleration/deceleration.</p>
--	---

8.2 Radius

 <pre> PARAMETERS 1/2 ----- ACCELERATION 3 DECELERATION 3 RADIUS mm 70 DENSITY g/cm³ 1.2 TEMP.OFFSET °C 0 CHAMBER DEL. min 1 </pre>	<p>RADIUS [mm] - control of the radius of the rotor within the range from R_{min} to R_{max}. Available values depends on chosen rotor, see -- / -- (LIST OF ROTORS field).</p> <ul style="list-style-type: none"> ▪ With ▲▼ keys mark RADIUS ▪ Press SET- appears. ▪ Via▲▼ keys choose demanded values. ▪ Press SET. ▪ Press BACK.
 <pre> RCF 0  ----- TIME  00:02:00 ----- TEMP +5°C +19 PRG-- 11716  MENU+ </pre>	<p>When radius is changed is activated,  symbol is visible on the screen.</p> <p>Displayed RCF will be computed in accordance with changed value of radius.</p>

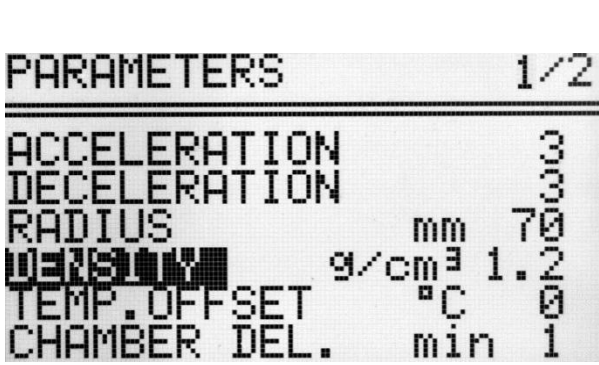
8.3 Density

 <pre> PARAMETERS 1/2 ----- ACCELERATION 3 DECELERATION 3 RADIUS mm 70 DENSITY g/cm³ 1.2 TEMP.OFFSET °C 0 CHAMBER DEL. min 1 </pre>	<p>DENSITY (g/cm^3) - default density is set to 1,2 g/cm^3 (possible values 1,2 ÷ 9,9 g/cm^3).</p> <ul style="list-style-type: none"> ▪ With ▲▼ keys mark DENSITY ▪ press ► ▪ Via▲▼ keys choose demanded values. ▪ Press SET- appears. ▪ Press BACK
--	--





When density is changed, symbol  is visible on the screen.

Increasing density of the sample above 1,2 g/cm³ (and limiting of the maximum speed of centrifuging resulting from it) applies until switching off power supply of the centrifuge or setting the device back to 1,2 g/cm³.

Increasing the density reduces the maximum speed of the rotor.

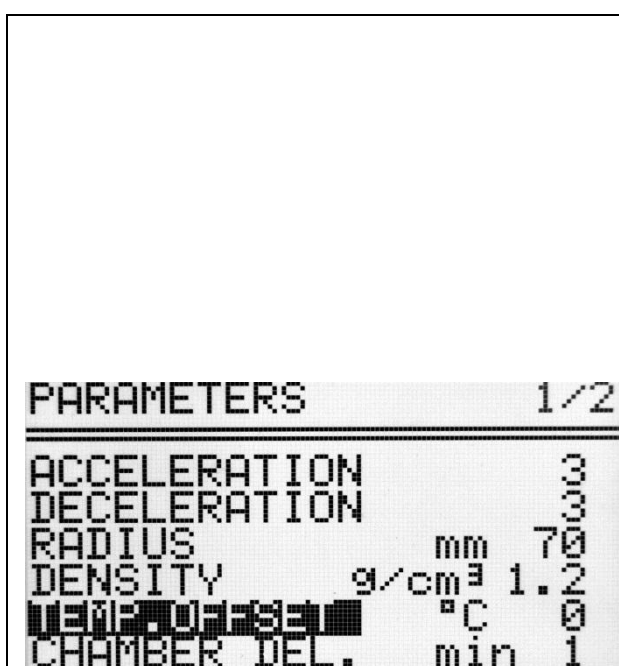
8.4 Temperature offset



- With ▲ ▼ keys select TEMP. OFFSET.
- Press SET- appears.
- Use the ▲ ▼ keys to select the difference between the temperature that the cooling system will aim for, and set temperature.
- Confirm selection by pressing SET.
- Press BACK

Attention!

The use of the offset can not extend the temperature range achieved by the centrifuge.



Function description

At a set temperature of 20°C and the set offset value equal to -5°C, cooling system will actually strive to reach 15°C. With a setpoint temperature of 20°C and a set offset value of 5°C the system will actually try to reach 25°C.



The temperature displayed on the main screen is corrected for offset value.

Offset can be selected range from -20°C to 20°C.





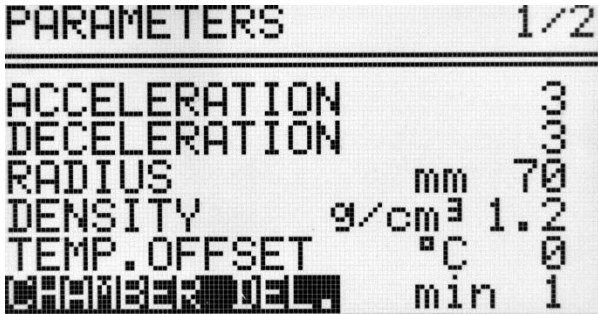

Activation of the function is signaled on the main screen with  or  depending on the offset value sign.



8.5 Thermal Chamber delay

	<ul style="list-style-type: none"> ▪ With ▲ ▼ keys choose CHAMBER DEL. ▪ Press SET -  appears. ▪ With ▲ ▼ keys select time value. ▪ Set demanded value by pressing ▲ ▼. ▪ Press SET. ▪ Press BACK.
---	---





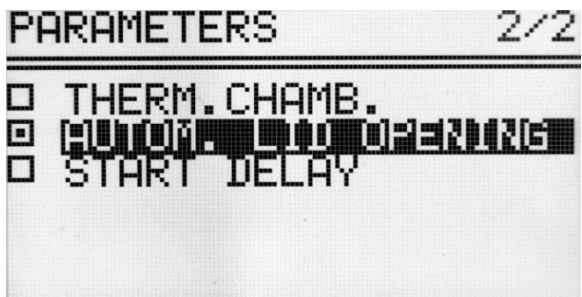

8.6 Thermal chamber (Constant temperature in chamber without centrifuging)

	<ul style="list-style-type: none"> ▪ Via ▲ ▼ ◀ ▶ keys choose THERM. CHAMB. ▪ Press SET (to switch off/on). ▪ Via ◀ ▶ keys mark value of temperature. ▪ Press SET -  appears. ▪ Via ▲ ▼ keys SET demanded temperature. ▪ Press BACK. ▪ Activation of thermal chamber is delayed in accordance with information content in chapter 8.5 Thermal chamber delay.
	<ul style="list-style-type: none"> ▪ When THERMAL CHAMBER function is activated,  symbol is blinking on the screen. ▪ Changing temperature from the main screen is not possible. ▪ Opening cover terminates THERM. CHAMB. function (closing cover back turns it on).
<ul style="list-style-type: none"> ▪ If THERMAL CHAMBER is turned on (in PARAM fold) and centrifugation completes, THERMAL CHAMBER will activate itself. ▪ THERMAL CHAMBER can be only activated when any other program is not running. 	

8.7 Automatic lid open





Automatic lid open	OPEN LID AFTER RUN
 <p>PARAMETERS 2/2</p> <p><input type="checkbox"/> THERM. CHAMB.</p> <p><input checked="" type="checkbox"/> AUTOM. LID OPENING</p> <p><input type="checkbox"/> START DELAY</p>	<ul style="list-style-type: none"> Via ▲▼◀▶ keys choose AUTOM. LID OPENING. Press SET (to switch off/on). When centrifuge process is finished, cover will be opened automatically. When centrifuging is terminated by pressing STOP, opening cover is possible by pressing COVER. Press BACK.
 <p>SPEED 2000 647 ▶</p> <p>TIME 00:02:00 00:01:57</p> <p>TEMP +5°C +18 PRG-- 11716 +5°C +18 PARA+ MENU+</p>	<ul style="list-style-type: none">  symbol means that OPEN LID AFTER RUN is active.

8.8 Start delay - of time

	Start centrifuging since preselected delay is reached.	START DELAY/OF TIME
 <p>PARAMETERS 2/2</p> <p><input type="checkbox"/> THERM. CHAMB.</p> <p><input type="checkbox"/> AUTOM. LID OPENING</p> <p><input checked="" type="checkbox"/> START DELAY</p> <p><input checked="" type="checkbox"/> OF TIME + 0:00:01</p> <p><input type="checkbox"/> OF TEMP + +7°C</p>		<ul style="list-style-type: none"> Via ▲▼ keys mark START DELAY. Press SET. Via ▼ keys mark OF TIME. Press SET -  appears. Via ▶ keys mark field 0:00:05 (for example). Press SET. Start delay can be set from 0:00:01 to 9:59:59. Confirm by pressing SET. Press BACK.
 <p>SPEED 2000 0 </p> <p>TIME ---:---:--- 00:00:03</p> <p>TEMP +5°C +17 PRG-- 11716 +5°C +17 PARA+ MENU+</p>		<p>When START DELAY-OF TIME function is activated,  symbol is visible on the screen.</p>
<p>It is possible to exit START DELAY -of time mode at any time by pressing STOP key.</p>		

START DELAY / OF TIME function cannot be run when START DELAY / OF TEMP. is activated.

8.9 Start delay – of temperature

	<p>Start centrifuging since preselected delay is reached.</p>	<p>START DELAY / OF TEMP</p>
	<ul style="list-style-type: none"> ▪ Via ▲ ▼ keys select START DELAY. ▪ Press SET. ▪ Via ▲ ▼ keys select OF TEMP. ▪ Press SET. ▪ Via ◀ ▶ keys select temperature zone. ▪ Press SET-  appears. ▪ Via ▲ ▼ keys set demanded value. ▪ Press SET. ▪ Press BACK. 	
	<p>When START DELAY – OF TEMP is turned on,  symbol is visible on the screen.</p>	
<p>When the function is active, the speed can be reduced to the optimum values for the FAST COOL function, when the set speed is lower than the optimum value, the rotor rotates at the set speed.</p>		
<p>It is possible to exit START DELAY –of temperature mode at any time by pressing STOP key.</p>		
<p>START DELAY / OF TEMP. function cannot be run when START DELAY / OF TIME is activated.</p>		

8.10 Screen messages

End of centrifuging – manual mode	
	<p>Centrifuging may be stopped at any moment via the STOP key. The information message: CYCLE CANCELLED will be displayed.</p>
End of centrifuging – manual mode	
	<p>Stopping centrifuging in accordance the set time causes generating multi-tone audible signals (after stopping the rotor) and displaying the message FINISH OF CENTRIFUGING</p>
Additional messages	
	<p>In case of power shortage while centrifuging, after repeated switching it on, the following error screen will be displayed: SUPPLY DECAY WHILE CENTRIFUGING</p>
	<p>After operating for 2000 hours, after every switching on the centrifuge the error screen is being displayed with information about the necessity to carry out servicing activities. After pressing the SET key, the device proceeds to the main screen and the device may operate.</p>
	<p>Identified number of the installed rotor is not compatible with the number of rotor remembered in program.</p>

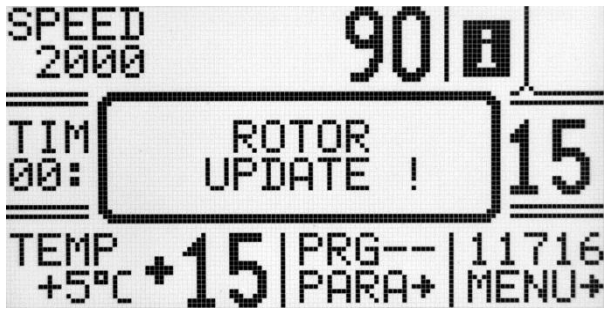
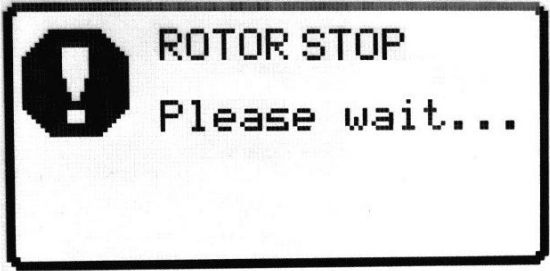
 <p>SPEED 2000 90 H </p> <p>TIM 00: ROTOR UPDATE ! 15</p> <p>TEMP +5°C +15 PRG-- 11716 +5°C +15 PARA+ MENU+</p>	<p>The rotor is automatically updated (when auto-identification is enabled).</p>
 <p>ROTOR STOP Please wait...</p>	<p>Rotor is braking (only when centrifuge was switched off during rotor running).</p>
<p>After pressing the SET or STOP key, the device returns to the main screen.</p>	

Screen messages that may occur during operation.

MESSAGE	EXPLANATION
"SPEED OF ROTOR" "IDENTIFICATION <> 90 RPM"	SPEED OF ROTOR IDENTIFICATION <> 90 RPM
"IMBALANCE FAST STOP!" "PLEASE REMOVE CAUSE" "THEN RESTART"	UNBALANCE DETECTED
"NO ROTOR OR IDENTIFICATION" "SENSOR DAMAGED!"	ERROR OF ROTOR IDENTIFICATION {LIMIT OF 6SEC. IS OVER}
"INCORRECT ROTOR NUMBER!"	ROTOR'S IS NOT CORRECT
"WRONG DIRECTION OF ROTATION" "OR UNKNOWN ROTOR!"	WRONG DIRECTION OF ROTATION / UNKNOWN ROTOR
"PLEASE CLOSE THE LID" "HAND!"	CLOSING THE LID MANUALLY
"ROTOR STOPPING!" "Please wait..."	INITIALIZING AFTER MAINS FAILURE WITH ROTATING ROTOR
" CYCLE'S ABORTED!"	CENTRIFUGATION ENDED BECAUSE STOP WAS PRESSED
" CYCLE'S FINISHED"	CENTRIFUGING ENDED {WITHOUT ERRORS}

Emergency messages

In case of emergency messages (centrifuge is not working properly) contact the manufacturer's authorized service centre.

MESSAGE
"OVERHEATING MOTOR!"
"INVERTER ERROR!"
"INVERTER SERIAL BUS ERROR!"
"TEMPERATURE SENSOR ERROR"
"OPENING COVER in RUN!"
"SPEED METER ERROR"
"I2C BUS ERROR"
"OVERHEATING CENTRIFUGE!"
"ROTOR OVERSPEED!"
"COVER LOCK MALFUNCTION!"
"WORKING 2000 HOURS:" "CALL SERVICE FOR"

8.11 Unbalance

The centrifuge is provided with the rotor unbalance sensor and when it will be activated, centrifugation process will be stopped through fast braking and at the same time an error message will be displayed. Cancellation of this error is possible only through pressing COVER key after stopping of the rotor.



One must check if rotor was correctly loaded, close the cover and once more start the program. In order to protect the rotor against beating in opposite areas of the rotor, it has to be provided with identically filled buckets, carriers, test-tubes etc. for getting the best balance possible.



	<p>Unbalance causes noise and vibrations during operation, and adversely affects power transmission system (motor, shock absorbers). The better balance, the smoother will be the centrifuge operation and therefore longer life of usage of the driveline. Moreover, the ideal separation level is then obtained, as already separated constituents would not be moved up by vibration.</p>
---	--

8.12 Emergency stop

At any moment of centrifuging it is possible to interrupt the process and fast stop the rotor. Single-time pressing of the STOP key will make centrifuging stop with acceleration characteristics set in the program (after pressing the SET or STOP key, the device returns to the main screen). Pressing and holding it up to 1s will make the centrifuging stop with the strictest characteristic.

9 MENU

Simplified display mode	
	<ul style="list-style-type: none"> Press and hold  by 1 second. Choose PARAM with ▲ ▼ Press SET. Execute points described follow (below Normal display mode description)

Normal display mode	
	<ul style="list-style-type: none"> Press SET –  appears. With ▲ ▼ ◀ ▶ keys select MENU (highlighted). Press SET.

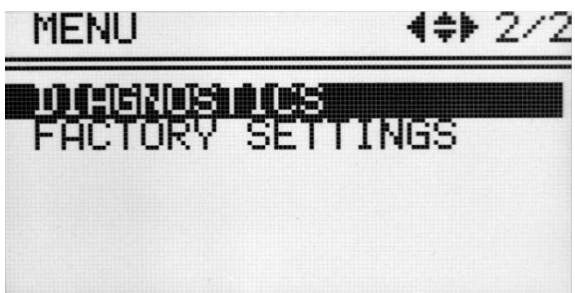
	<ul style="list-style-type: none"> Moving in the MENU is possible via ▲ ▼ ◀ ▶ keys. To open demanded field one should mark it and press SET.
	

CONFIGURATION	centrifuge configuration
PASSWORD	password protection
LAST 10 CYCLES	10 last centrifugation cycles history
WORK TIME	total working time, working cycles counter
ROTOR RUNTIME	counting time mode
CONTACT US	manufacturer's details
DIAGNOSTICS	error codes (service field)
FACTORY SETTINGS	restore factory settings

9.1 Screen saver

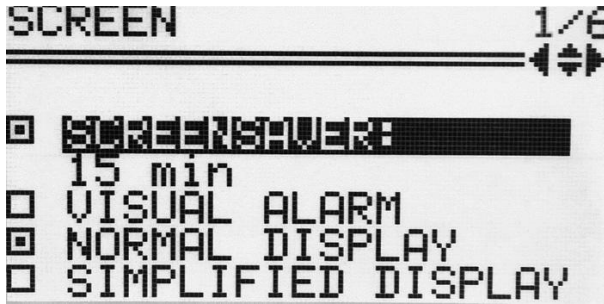
Setting time of screen saver	MENU / CONFIGURATION / SCREEN MODE
 <p>SCREEN 1/6</p> <p>SCREENSAVER: 15 min</p> <p>VISUAL ALARM</p> <p>NORMAL DISPLAY</p> <p>SIMPLIFIED DISPLAY</p>	<ul style="list-style-type: none"> With ▲▼ keys select SCREENSAVER. Press SET. With ▲▼ keys choose 15 min (highlighted). Press SET-+/- appears. With ▲▼ keys select demanded value from 1 to 60 minutes. Mark selection by pressing SET. Leave the menu by pressing BACK.

9.2 Visual alarm

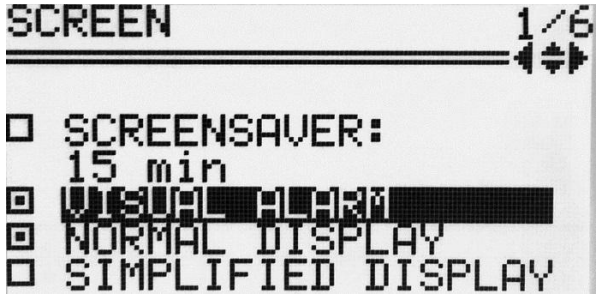
Visual alarm	MENU / CONFIGURATION / SCREEN MODE
 <p>SCREEN 1/6</p> <p>SCREENSAVER: 15 min</p> <p>VISUAL ALARM</p> <p>NORMAL DISPLAY</p> <p>SIMPLIFIED DISPLAY</p>	<ul style="list-style-type: none"> Via ▲▼ keys choose VISUAL ALARM Mark it by pressing SET. Leave the menu by pressing BACK. <p>VISUAL ALARM will cause blinking screen after ending of centrifuging or after error occurring.</p>

9.3 Types of main screen

Default setting is NORMAL DISPLAY.

To switch to SIMPLIFIED SCREEN, follow the rules in section 9.3.1.



Types of main screen	
NORMAL DISPLAY	SIMPLIFIED DISPLAY

9.3.1 Switching the normal display to simplified screen

Method I	
	<ul style="list-style-type: none"> ▪ Press SET – appears. ▪ Via keys select MENU. ▪ Press SET. ▪ Via keys select CONFIGURATION tab. ▪ Press SET. ▪ Via keys select SIMPLIFIED DISPLAY. ▪ Press SET. ▪ Leave menu via BACK key.
Method II	
	<p>Press the BACK button for 1 sec. to return to the basic display (a short menu is displayed on the screen), then:</p> <ul style="list-style-type: none"> ▪ Via keys select SIMPLIFIED DISPLAY. ▪ Press SET.

9.3.2 Switching the simplified screen to normal display

	<p>Press the BACK button for 1 sec. to return to the basic display (a short menu is displayed on the screen), then:</p>
--	---

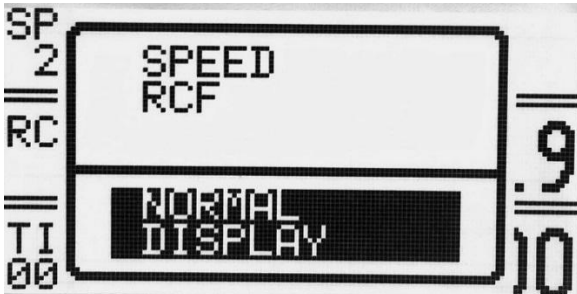
	
	<ul style="list-style-type: none"> ▪ Via ▲▼ keys select DISPLAY tab. ▪ Press SET. <p>(a new selection window is displayed on the screen)</p>
	<ul style="list-style-type: none"> ▪ Via ▲▼ keys select NORMAL DISPLAY tab. ▪ Press SET.

9.4 Rotating time

The method of counting time centrifuging	MENU/CONFIGURATION/ ROTATING RUNTIME
	<ul style="list-style-type: none"> ▪ Via ▲▼ choose demanded option. ▪ Mark it by pressing SET. ▪ Leave menu via BACK key
<u>Counting since:</u> FROM PRESSING START FROM REACHING SPEED	COUNTING SINCE ROTOR IS IDENTIFIED COUNTING FROM ASSIGNED SPEED
<u>Presenting mode:</u> DESCENDING ASCENDING	COUNTING DOWN COUNTING UP

9.5 Buzzer

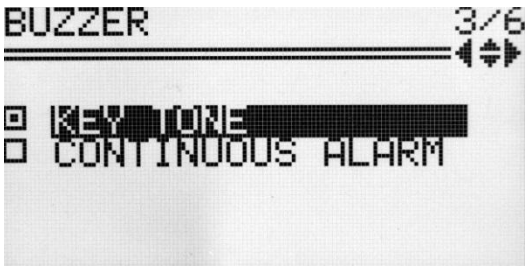
Switching ON/OFF short audible signals accompanying every pressing of any key.	MENU/ CONFIGURATION /BUZZER
 A screenshot of a monochrome LCD display showing a menu titled 'BUZZER' at the top left and '3/6' at the top right. Below the title is a horizontal line. Underneath, there are two menu items: 'KEY TONE' with a small square icon to its left, and 'CONTINUOUS ALARM' with a small square icon to its left. The 'KEY TONE' option is highlighted with a thick black bar behind it. To the right of the 'BUZZER' title, there are four arrow icons (left, up, down, right) indicating navigation options.	<ul style="list-style-type: none">▪ With ▲▼ keys select demanded option.▪ Mark selection by pressing SET.▪ Leave menu via BACK key
Warning signals are always switched on.	

9.6 Date/time

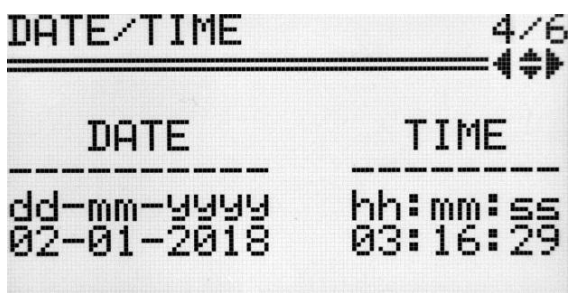
Setting up time and date	MENU/ CONFIGURATION /DATE/TIME
	<ul style="list-style-type: none"> ▪ Press SET. ▪ Via ◀▶ keys choose demanded value. ▪ Press SET - [SET] appears. ▪ Via ▲▼ keys change chosen value. ▪ Repeat above steps for other values. ▪ Confirm by pressing SET. ▪ Press BACK.
Set date and time are still active even after restart of centrifuge.	

9.7 Language

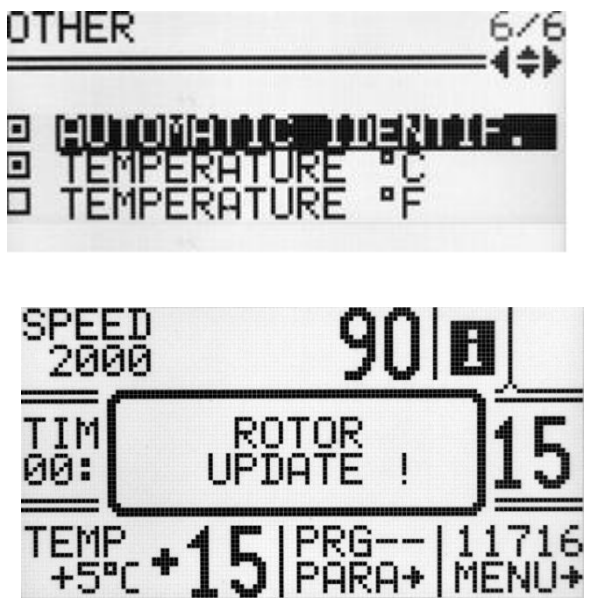

Changing menu language	MENU / CONFIGURATION / LANGUAGE
	<ul style="list-style-type: none"> ▪ Via ▲▼◀▶ keys choose demanded menu language ▪ Mark it by pressing SET. ▪ Press BACK.

9.8 Other

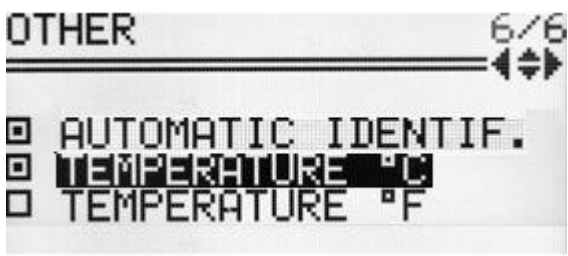
Rotor automatic identification	MENU / CONFIGURATION / OTHER
	<p>Thanks to the AUTOMATIC IDENTIFICATION, the centrifuge automatically identifies the rotor in the chamber. Rotor identification is indicated by the message.</p> <p>When the function is deactivated, it is necessary to manually select the desired rotor as described in "6.5 Choosing rotors".</p> <p>The AUTOMATIC IDENTIF. is turned on by default.</p> <p>To enable the function: Via ▲▼ keys choose <input type="checkbox"/> AUTOMATIC IDENTIF. Press SET (<input type="checkbox"/> change to <input checked="" type="checkbox"/>).</p> <p>After rotor automatic correction ROTOR UPDATE! is visible</p>

Choice of temperature unit	MENU / CONFIGURATION / OTHER
 <p>OTHER 6/6 <input checked="" type="checkbox"/> AUTOMATIC IDENTIF. <input checked="" type="checkbox"/> TEMPERATURE °C <input type="checkbox"/> TEMPERATURE °F</p>	<p>The TEMPERATURE in °C is turned on by default. To change the temperature unit:</p> <ul style="list-style-type: none"> ▪ Via ▲▼ keys select unit ▪ Confirm by pressing SET.

9.9 Password protection

Setting up password	MENU / PASSWORD
<p>To prevent from an unauthorized use, a PASSWORD can be set. Note: No PASSWORD is set by default. The PASSWORD can be set as follows when the rotor is at a standstill.</p>	
	<ul style="list-style-type: none"> ▪ Press the ▲▼ keys until PASSWORD. ▪ Press SET: +/- appears. ▪ With ◀▶ keys set the valid 1000s place of the PASSWORD. e.g.: 1xxx. With ▲▼ keys set correct value. ▪ Repeat above steps for all places. ▪ Press SET.
	<ul style="list-style-type: none"> ▪ As a confirmation repeat instructions described above.
<p>When the PASSWORD is set, the Key sign is displayed in the CODE zone. It is also displayed in the main menu (lower right corner of the screen).</p>	

LOCK: <hr/> <input type="checkbox"/> SAVE PROGRAM <input type="checkbox"/> DELETE PROGRAM <input type="checkbox"/> CHANGE PARAMETERS <input type="checkbox"/> LOAD PROGRAM <input type="checkbox"/> START KEY	SPEED 0 ■ ? 12000 <hr/> TIME [] 00:02:00 00:02:00 <hr/> TEMP +21 PRG-- 11944 +20°C + PARA+ MENU+
--	--

From then on, access to the MENU is possible after entering the password.

In case of incorrect password, it will show message: ACCESS DENIED!

To delete the PASSWORD, "0000" must be set.

If the PASSWORD is forgotten, the emergency code "7654" should be used to clear password and remove all locks.

9.10 Cycles history

Information concerning parameters of last 10 centrifuging cycles.	CONFURATION / LAST 10 CYCLES
NO CYCLES: 10 ◀▶ <hr/> DATE: 2018.01.02 TIME: 03:17 PROG: -- ROTOR: 11716 SPEED: 2000 RCF: 313	<ul style="list-style-type: none"> Number of cycle can be changed by ◀▶ keys. The list can be scrolled using ▲▼ keys. To exit press BACK key.

9.11 Total work time

Total working time of centrifuge	CONFIGURATION / WORK TIME
WORK TIME <hr/> TOTAL RUN TIME: 0h 13m 14s CYCLES: 31	<p>In the CYCLES menu the following statistics are displayed:</p> <ul style="list-style-type: none"> total working (centrifugation) time working cycles counter To exit press BACK key.

9.12 Rotor cycles

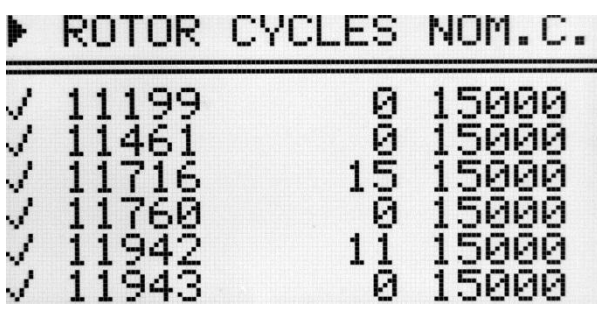
<p>Information about the time of centrifuging and of the quantity of the working cycles of each rotor. The table also contains icons warning of the duty of execution of validation.</p>	<p>CONFIGURATION / ROTOR RUNTIME</p>
 <pre> ▶ ROTOR CYCLES NOM.C. ----- ✓ 11199 0 15000 ✓ 11461 0 15000 ✓ 11716 15 15000 ✓ 11760 0 15000 ✓ 11942 11 15000 ✓ 11943 0 15000 </pre>	<ul style="list-style-type: none"> ▪ The list can be scrolled using ▲▼ keys. ▪ To exit press BACK key. <p>Symbols:</p> <ul style="list-style-type: none"> ✓ – more than 100 cycles left ! – less than 100 cycles left ■ – worn rotor

9.13 Diagnostics

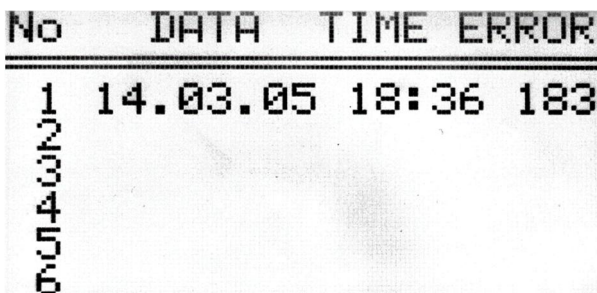
<p>Information about errors arisen in working of the centrifuge.</p>	<p>CONFIGURATION / DIAGNOSTICS</p>
 <pre> No DATA TIME ERROR ----- 1 14.03.05 18:36 183 NO </pre>	<ul style="list-style-type: none"> ▪ Use the ▲▼ buttons to select the desired error. ▪ To exit press BACK key.

9.14 Factory settings

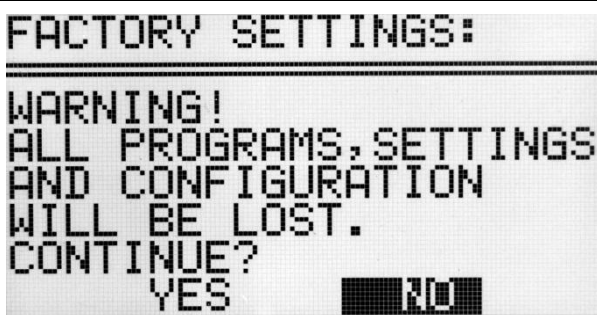
<p>Restoring factory settings.</p>	<p>MENU/ FACTORY SETTINGS</p>
<p>All settings of user programs will be deleted.</p>	
 <pre> FACTORY SETTINGS: ----- WARNING! ALL PROGRAMS, SETTINGS AND CONFIGURATION WILL BE LOST. CONTINUE? YES NO </pre>	<ul style="list-style-type: none"> ▪ Via ◀▶ keys choose YES or NO. ▪ Confirm by pressing SET.

9.15 *Manufacturer's details*

Information about the type of the centrifuge, firmware version, and contact details.	CONFIGURATION / CONTACT US
CONTACT US	<ul style="list-style-type: none"> ▪ The list can be scrolled using ▼▶◀▶ keys. ▪ To exit press BACK key.
<p style="text-align: center;">LABNET INTERNATIONAL 33 WOOD AVE. SOUTH ISELIN, NJ 08830</p> <hr style="border-top: 1px dashed black;"/> <p style="text-align: center;">WWW.LABNETINTERNATIONAL.COM LABNETINFO@CORNING.COM</p>	

10 Maintenance

10.1 *Cleaning of the centrifuge*

	<p>Attention!</p> <ul style="list-style-type: none"> ▪ Pull the mains plug before cleaning. ▪ Before any cleaning or decontamination process other than that is recommended by the manufacturer, the user has to ask the manufacturer if the planned process does not damage the device.
	<ul style="list-style-type: none"> ▪ For cleaning, water with soap or other water soluble mild detergent shall be used. ▪ One should avoid corrosive and aggressive substances. It is prohibited to use alkaline solutions, inflammable solvents or agents containing abrasive particles. ▪ Do not lubricate the centrifuge motor shaft. ▪ The unused centrifuge should have cover opened. <p>Once a week</p> <p>Using wiping cloth, remove condensate or residues of the products from the rotor chamber.</p> <p>Once a month</p> <p>Check the rotor clamping thread. In case of damage, replaced it.</p> <p>Check the centrifuging chamber whether it is damaged. In case of damage it can not be longer put into operation. Notify authorized service workshop.</p>

10.2 *Maintenance of centrifuge elements*

	<ul style="list-style-type: none"> ▪ In this way, the uniform deflection of the buckets and quiet centrifuge operation is ensured.
---	---

Cleaning of the accessories

	<ul style="list-style-type: none"> ▪ In order to ensure safe operation one shall carry out in regular way periodical maintenance of the accessories. ▪ Rotors, buckets and round carriers have to withstand high stresses originating from the centrifugal force. Chemical reactions as well as corrosion (combination of variable pressure and chemical reactions) can cause destruction of metals. Hard to observe surface cracks increase gradually and weaken material without visible symptoms. <p>Wipe rotor's pins clean and dry with a paper towel after approx. 400 uses, cleaning or/and autoclaving and then lubricate socket with the petroleum jelly.</p>
---	--

	<ul style="list-style-type: none"> ▪ In case of observation of surface damage, crevice or other change, as well as the corrosion, the given part (rotor, bucket, etc.) shall be immediately replaced. ▪ Clamping rotor, containers and reducer inserts must be cleaned regularly to prevent corrosion. ▪ Cleaning of the accessories shall be carried out outside of the centrifuge once every week or still better after each use. For cleaning them one should use neutral agent of pH value 6÷8. It is forbidden to use alkaline agent of pH > 8. Then, those parts shall be dried using soft fabric or in the chamber drier at ca. 50°C. ▪ Angle rotor should be placed on a fabric with holes facing down, for effective drying. ▪ Do not use bleach on plastic parts of the rotor. ▪ In this way, the useful service life of the device is substantially increased and susceptibility to corrosion is diminished. Accurate maintenance increases the service life as well and protects against premature rotor failures. <p>Do not use bleach on plastic parts of the rotor.</p> <p>According to laboratory standards, minimize the immersion time in each solution.</p> <ul style="list-style-type: none"> ▪ Especially prone to the corrosion are parts made of aluminium. ▪ Corrosion and damages resulting from insufficient maintenance could not be subject of claims lodged against the manufacturer. ▪ The unused rotor should have the lid removed.
--	--

- HS accessories maintenance.

	<ul style="list-style-type: none"> ▪ Check the general condition of seals. ▪ Make sure that rubber O-rings are lightly coated with silicone grease. Use high vacuum grease. ▪ The rotor pins shall be always lubricated with petroleum jelly.
---	--

10.3 Sterilization

Plastics - legend to abbreviations

PS	polystyrene	ECTFE	ethylene/chlorotrifluoroethylene
SAN	styrene-acrylonitrile	ETFE	ethylene/tetrafluoroethylene
PMMA	polymethyl methacrylate	PTFE	polytetrafluoroethylene
PC	polycarbonate	FEP	tetrafluoroethylene/perfluoropropylene
PVC	polyvinyl chloride	PFA	tetrafluoroethylene/perfluoroalkylvinylether
POM	acetal polyoxymethylenel	FKM	fluorcarbon rubber
PE-LD	low density polyethylene	EPDM	ethylene propylene diene
PE-HD	high density polyethylene	NR	natural rubber
PP	polypropylene	SI	silicon rubber
PMP	polymethyl pentene		

One can use all standard disinfectants. Centrifuges and devices are made of different materials, one should consider their variety.

	radiation β radiation γ 25 kGy	C ₂ H ₄ O (ethylene oxide)	formalin, ethanol
PS	●	○	●
SAN	○	●	●
PMMA	●	○	●
PC	●	●	●
PVC	○	●	●
POM	●	●	●
PE-LD	●	●	●
PE-HD	●	●	●
PP	●	●	●
PMP	●	●	●
ECTFE, ETFE	○	●	●
PTFE	○	●	●
FEP, PFA	○	●	●
FKM	○	●	●
EPDM	○	●	●
NR	○	●	●
SI	○	●	●

- may be used
- cannot be used

In the centrifuge, disinfectants and cleaning agents generally used in medical care should be used (e.g. Aerodesina-2000, Lysoformin 3000, Melseptol, Melsept SF, Sanepidex, Cutasept F).

10.3.1 Autoclaving

- Rotors, buckets and round carriers can be sterilized in autoclave with temperature 121°C during 20 min (215 kPa), unless otherwise specified in the OPTIONAL ACCESSORY.
- During sterilization (autoclaved) by means of steam one should to consider temperature resistance of individual materials.
- Deformation of the accessories (carriers or lids made of plastic) may occur during autoclaving.
- Do not autoclave disposable materials (e.g. tubes, cyto-container).
- The life of the accessory depends on the frequency of autoclaving and use.
- Autoclaving reduce lifespan of plastic and mechanical components. PC tubes can become useless.
- Pressure in closed containers can cause plastic deformation or explosion.
- Prior to autoclaving the rotors and accessories, thoroughly wash and rinse with distilled water.
- Never exceed the permissible autoclaving temperature and time.
- If you want to keep the hermetic seals, replace the sealing rings after each autoclave.

Chemical resistance of plastics

	autoclaving 121 °C, 20 min		autoclaving 121 °C, 20 min
PS	○	PMP	●
SAN	○	ECTFE, ETFE	●
PMMA	○	PTFE	●
PC	●	FEP, PFA	●
PVC	○ ¹⁾	FKM	●
POM	●	EPDM	●
PE-LD	○	NR	○
PE-HD	○	SI	●
PP	●		

● may be used

○ cannot be used

1) Except PVC hoses which are resistant to the steam sterilization in the temperature 121°C.

10.4 Chemical resistance

Chemical resistance of plastics

Rubber inserts shall be exactly cleaned or possibly replaced. Centrifuges and accessories are made of different materials.

Do not use bleach on plastic parts of the rotor.

	aldehydes	cyclic alcohols	esters	ether	ketones	strong or concentrated acids	weak or diluted acids	oxidizing substances	cyclic hydrocarbons	ahs	haloid hydrocarbons	alkalis
PS	○	●	○	○	○	○/●	○/●	○	○	○	○	●
SAN	○	●	○	○	○	○	○/●	○	○	○	○	●
PMMA	○/●	●	○	○	○	○	○/●	○	○/●	○	○	○
PC	○/●	●	○	○	○	○	○/●	○	○/●	○	○	○
PVC	○	●	○	○	○	●	●	○	●	○	○	●
POM	○/●	●	○	●	●	○	○	○	●	●	●	●
PE-LD		●	●	●	○/●	●	●	○	●	●	●	●
PE-HD	●	●	○/●	○/●	○/●	●	●	○	●	○/●	○/●	●
PP	●	●	○/●	○/●	○/●	●	●	○	●	○/●	○/●	●
PMP	○/●	●	○/●		○/●	●	●	○	○/●	○	○	●
ECTFE, ETFE	●	●	●	●	○	●	●	●	●	●	●	●
PTFE, FEP, PFA	●	●	●	●	●	●	●	●	●	●	●	●
FKM	●	○	○	○	○	○	●	○/●	○/●	○/●	○/●	○/●
EPDM	●	●	○/●	○	○/●	●	●	○/●	○	○	○	●
NR	○/●	●	○/●	○	○	○	○/●	○	○	○	○	●
SI	○/●	●	○/●	○	○	○	○/●	○	○	○	○	○/●



DANGER!







Labnet accessories are not biotite. For centrifuging infectious materials, it is necessary to use hermetically closed tubes meeting demands of bio tightness, in order to prevent germs migration into the centrifuge and beyond it.





User is responsible for proper disinfections of the centrifuge, if some dangerous material was spilled inside or outside of the centrifuge. During the above mentioned works one must wear safety gloves.

11 Troubleshooting

Majority of faults could be removed by restart the centrifuge. After switching the centrifuge ON, there shall be displayed parameters of the recently implemented program and sound signals comprising four successive tones shall be generated. In case of short-duration power failure the centrifuge terminates the cycle and displays PROGRAM ERROR code.

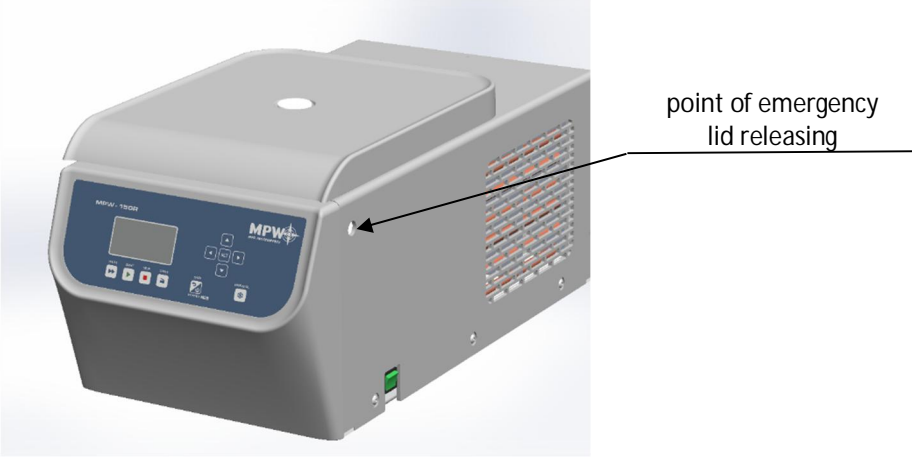
problem	question	remedy
Centrifuge does not start	<i>Is supply cable plugged into mains?</i>	<i>Plugs supply cable correctly.</i>
	<i>Is master switch ON?</i>	<i>Switch ON power supply.</i>
<i>Motor error is displayed</i>		Call service.
Centrifuge does not start (indications are proof for cycle in progress and motor does not start)	<i>Is  symbol displayed?</i>	Wait till rotor stops and the  symbol goes off.
	<i>Is  symbol displayed?</i>	Close cover.  symbol must switch off.
	<i>Is  symbol blinking?</i>	Centrifugation cycle in progress, press STOP key or wait till cycle ends.
Centrifuge does not accelerate (unbalance error)	<i>Unequal rotor load.</i>	Centrifuge load shall be balanced.
	<i>Inclined centrifuge.</i>	Centrifuge shall be levelled.
	<i>Faulty drive (mechanical damage).</i>	Call service.
	<i>Was centrifuge displaced during operation.</i>	Switch ON the centrifuge again after opening and closing the cover.
(rotor error)	<i>After stopping error rotor message is displayed</i>	Check if rotor number in started program is consistent with the number of the rotor installed in the centrifuge. Check rotor status (if there are coding magnets inserted)
	<i>Centrifuge does not recognize the rotor and does not stop.</i>	Switch the centrifuge OFF, then ON and check correctness of loaded program
It is not possible to open the cover	<i> symbol on the display is blinking, after pressing COVER key single tone is audible</i>	Rotor is still rotating. Wait for stopping of the rotor and displaying of the  symbol.
	<i>The sensor is connected correctly, and the error is still applying.</i>	Call service.
Mains failure during run	<i>The message will be displayed on the display about the decay of tension.</i>	Wait for stopping of the rotor, clear the error by pressing the SET key.
Temperature sensor error	<i>The overheating message will be displayed.</i>	Switch the centrifuge OFF, then ON.
		Call service.
Error of the exceeding the temperature (50°C) in the chamber	<i>The overheating message will be displayed.</i>	Call service.

	<p>Emergency lid release</p> <p>In case of e.g. mains failure it is possible to open cover manually. On the right side is plug, which should be unscrew (via key for emergency lid release 18640 basic accessories). Then, one should pull the plug.</p> <div style="text-align: center;">  </div> <p><i>It is not allowed to emergency lid releasing when rotor is running! One must be sure that rotor is not in the motion (use inspection glass).</i></p>
---	--

	<p>Screen failure</p> <p>If the information displayed on the screen disappears and there is no display backlight, press the STOP button twice to stop the centrifuging. Then, make sure to look through the viewfinder into the centrifuge chamber that the rotor has stopped rotating and turn off the power supply with the power switch.</p> <p>For reasons of safety, do not use the lid emergency opening. 5 minutes after stopping the rotor turn on the power supply with the power switch.</p>
---	---

12 Limited Warranty

Corning Incorporated (Corning) warrants that this product will be free from defects in material and workmanship for a period of two (2) years from date of purchase. CORNING DISCLAIMS ALL OTHER WARRANTIES WHETHER EXPRESSED OR IMPLIED, INCLUDING ANY IMPLIED WARRANTIES OF MERCHANTABILITY OR OF FITNESS FOR A PARTICULAR PURPOSE. Corning's sole obligation shall be to repair or replace, at its option, any product or part thereof that proves defective in material or workmanship within the warranty period, provided the purchaser notifies Corning of any such defect. Corning is not liable for any incidental or consequential damages, commercial loss or any other damages from the use of this product.

This warranty is valid only if the product is used for its intended purpose and within the guidelines specified in the supplied instruction manual. This warranty does not cover damage caused by accident, neglect, misuse, improper service, natural forces or other causes not arising from defects in original material or workmanship. This warranty does not cover motor brushes, fuses, light bulbs, batteries or damage to paint or finish. Claims for transit damage should be filed with the transportation carrier.

In the event this product fails within the specified period of time because of a defect in material or workmanship, contact Corning's Customer Service at the following numbers: USA: 1-800-492-1110; Canada: 1-978-442-2200. For other regions of the world, please visit www.corning.com/lifesciences or see the included instruction manual for a list of World Wide Support Offices.

Corning's Customer Service team will help arrange local service where available or coordinate a return authorization number and shipping instructions. Products received without proper authorization will be returned. All items returned for service should be sent postage prepaid in the original packaging or other suitable carton, padded to avoid damage. Corning will not be responsible for damage incurred by improper packaging. Corning may elect for onsite service for larger equipment.

Some states do not allow limitation on the length of implied warranties or the exclusion or limitation of incidental or consequential damages. This warranty gives you specific legal rights. You may have other rights which vary from state to state.

No individual may accept for, or on behalf of Corning, any other obligation of liability, or extend the period of this warranty.

For your reference, make a note of the serial number, date of purchase and supplier here.

Serial No. _____ Date Purchased _____

Supplier _____

Warranty/Disclaimer: Unless otherwise specified, all products are for research use only. Not intended for use in diagnostic or therapeutic procedures. Corning makes no claims regarding the performance of these products for clinical or diagnostic applications.

13 Disposal



- According to Directive 2012/19/EU of the European Parliament and of the Council of 4 July 2012 on waste electrical and electronic equipment (WEEE), the centrifuge is marked with the crossed-out wheeled bin and must not be disposed of with domestic waste.
- Consequently, the buyer shall follow the instructions for reuse and recycling of waste electronic and electrical equipment (WEEE) provided with the products and available at the following link: www.corning.com/weee
- According to Directive 2006/66/EC of 6 September 2006 "on batteries and accumulators and waste batteries and accumulators" as amended, batteries must be collected separately to achieve a high level of recycling. They shall only be disposed of in accordance with national legislation.

14 Manufacturer's info





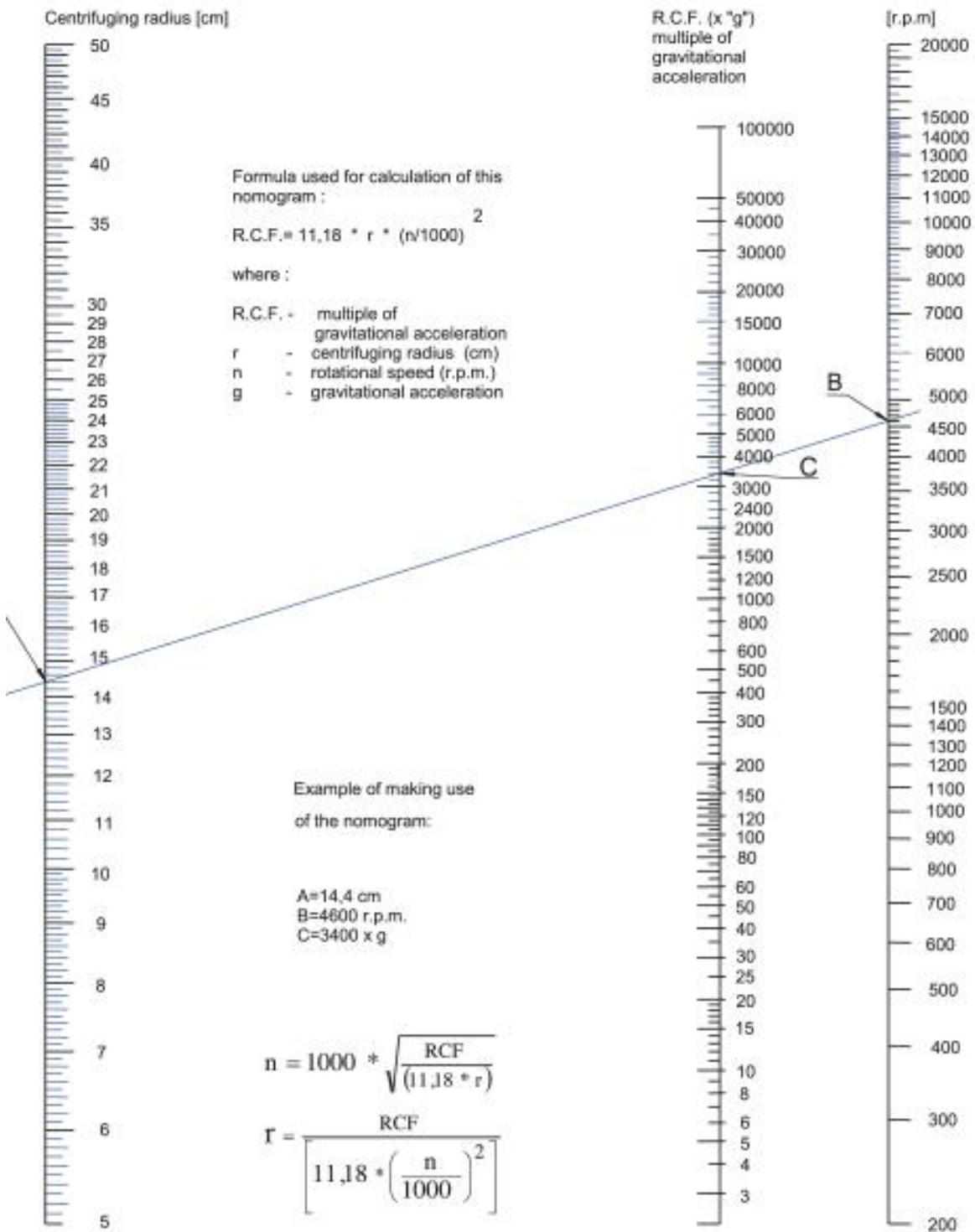

CORNING INCORPORATED	800-492-1110 option 2	Customer Service
	800-492-1110 Option 5	Service/technical support
271 County Route 64 Big Flats, NY 14814	http:// e-mail:	www.labnetinternational.com labnetinfo@corning.com

15 Annexes

Nomogram

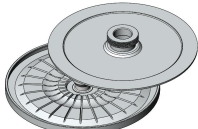

Available Rotors

Cat. No	Description	Rotor image
C0226-4PCR	Fixed angle rotor for 4 x 8 – 0.2 ml PCR strip tubes	
C0226-242SC	Fixed angle rotor for 24 x 1.5/2.0 ml filter tubes/spin columns	
C0226-610	Fixed angle rotor 6 x 10 ml, complete with buckets for 17 x 70/85 mm tubes	
C0226-615	Fixed angle rotor 6 x 15/10ml, complete with buckets for 17 x 100/120 mm tubes	
C0226-125	Fixed angle rotor for 12 x 5 ml tubes	
C0226-242	Fixed angle rotor 24 x 2/1.5 ml tubes	
C0336-HEM	Hematocrit fixed angle rotor	

NOTES:



Corning Incorporated
271 County Route 62
Big Flats, NY 14814
www.labnetinternational.com
labnetinfo@corning.com

LN182000

© 2018 Corning Incorporated