

Register your instrument!
www.eppendorf.com/myeppendorf



Centrifuge 5910 R

Original instructions
Originalbetriebsanleitung
Notice originale
Manual original
Istruzioni originali
Manual original

Copyright © 2017 Eppendorf AG, Germany. All rights reserved, including graphics and images. No part of this publication may be reproduced without the prior permission of the copyright owner.

Corning® is a registered trademark of Corning Inc., USA.

Microtainer® is a registered trademark of Becton Dickinson, USA.

Eppendorf® and the Eppendorf Brand Design are registered trademarks of Eppendorf AG, Germany.

Eppendorf QuickLock®, and FastTemp pro® are registered trademarks of Eppendorf AG, Germany.
FastTemp™ is a protected trademark of Eppendorf AG, Germany.

Registered trademarks and protected trademarks are not marked in all cases with ® or ™ in this manual.

U.S. Design Patents are listed on www.eppendorf.com/ip

Table of contents

1	Operating instructions	7
1.1	Using this manual	7
1.2	Danger symbols and danger levels	7
1.2.1	Danger symbols	7
1.2.2	Danger levels	7
1.3	Symbols used	7
1.4	Abbreviations used	8
2	Safety	9
2.1	Intended use	9
2.2	User profile	9
2.3	Information on product liability	9
2.4	Application limits	9
2.4.1	Declaration concerning the ATEX directive (2014/34/EU)	9
2.5	Warnings for intended use	10
2.5.1	Personal injury or damage to the equipment	10
2.5.2	Incorrect handling of the centrifuge	12
2.5.3	Incorrect handling of the rotors	12
2.5.4	Extreme strain on the centrifuging tubes	14
2.6	Safety instructions on the device and accessories	14
3	Product description	15
3.1	Product overview	15
3.2	Delivery package	16
3.3	Features	16
3.4	Name plate	17
4	Installation	19
4.1	Selecting the location	19
4.2	Preparing installation	20
4.3	Installing the instrument	20
5	Operation	21
5.1	Operating controls	21
5.2	Switching on the centrifuge	23
5.3	Initial steps	23
5.3.1	Setting the menu language	23
5.3.2	Setting date and time	23
5.4	Replacing the rotor	24
5.4.1	Inserting the rotor	24
5.4.2	Removing the rotor	24
5.4.3	Triggering rotor detection	25
5.5	Loading a fixed-angle rotor	26
5.5.1	Closing the rotor lid	26
5.5.2	Closing the QuickLock rotor lid	27

5.6	Loading the swing-bucket rotor	28
5.6.1	Inserting the bucket in the swing-bucket rotor.	29
5.6.2	Performing an imbalance calibration	29
5.6.3	Loading buckets symmetrically.	30
5.6.4	Closing the bucket with the cap	32
5.6.5	Mixed equipping with different buckets.	32
5.7	Closing the centrifuge lid	33
5.8	Aerosol-tight centrifugation	34
5.8.1	Aerosol-tight centrifugation in a fixed-angle rotor	34
5.8.2	Aerosol-tight centrifugation in a swing-bucket rotor	34
5.9	Centrifugation	35
5.9.1	Centrifugation with time setting	35
5.9.2	End of centrifugation	36
5.9.3	Centrifuging in continuous operation.	36
5.9.4	Short spin centrifugation	37
5.9.5	Setting the radius	37
5.9.6	Setting the acceleration ramp and braking ramp	38
5.9.7	Setting the start of time counting (At set rpm function)	38
5.10	Cooling	38
5.10.1	Setting the temperature	38
5.10.2	Temperature display	38
5.10.3	Temperature monitoring	39
5.10.4	Temperature control run FastTemp.	39
5.10.5	FastTemp pro: automatic temperature control run with programmed start time.	40
5.10.6	Continuous cooling	41
5.10.7	Endless operation of continuous cooling	41
5.11	Switching off the centrifuge	42
6	Device settings	43
6.1	Standby mode	43
6.1.1	Switching on the standby mode	43
6.2	Key lock.	43
6.3	Display.	44
6.3.1	Showing the set value row	44
6.3.2	Setting the contrast.	44
6.4	Speaker	44
6.4.1	Switching the loudspeaker on/off	44
6.4.2	Setting the volume	44
6.5	Calling up device information	44
6.6	Cycle counter	45
6.6.1	Notes on reaching the maximum number of cycles	45
6.6.2	Resetting the number of cycles.	46
6.6.3	Changing the number of cycles	46

7	Programs	47
7.1	Saving the program.....	47
7.1.1	Creating a program.....	47
7.1.2	Quick save with program keys.....	48
7.2	Loading a saved program.....	48
7.2.1	Loading program prog 1 to prog 5.....	48
7.2.2	Loading a program from the program list.....	49
7.2.3	Editing programs.....	50
7.3	Deleting a program.....	50
8	Maintenance	51
8.1	Maintenance.....	51
8.2	Preparing cleaning/disinfection.....	51
8.3	Cleaning/disinfection.....	52
8.3.1	Cleaning and disinfecting the device.....	52
8.3.2	Disinfecting and cleaning the rotor.....	53
8.3.3	Changing the seal of the aerosol-tight cap (S-4xUniversal, S-4x750, S-4x400).....	54
8.4	Additional care instructions for refrigerated centrifuges.....	54
8.5	Cleaning glass breakage.....	55
8.6	Resetting the excess current switch.....	55
8.7	Decontamination before shipment.....	56
9	Troubleshooting	57
9.1	General errors.....	57
9.2	Error messages.....	58
9.3	Emergency release.....	60
10	Transport, storage and disposal	61
10.1	Transport.....	61
10.2	Storage.....	61
10.3	Disposal.....	61
11	Technical data	63
11.1	Power supply.....	63
11.2	Weight/dimensions.....	63
11.3	Noise level.....	63
11.4	Ambient conditions.....	64
11.5	Application parameters.....	64
11.6	Acceleration and deceleration times.....	65
11.7	Service life for accessories.....	66

Table of contentsCentrifuge 5910 R
English (EN)

12 Rotors for the Centrifuge 5910 R	69
12.1 Rotor S-4xUniversal	69
12.1.1 Swing-bucket rotor S-4xUniversal with 4 Universal Buckets	69
12.1.2 Swing-bucket rotor S-4xUniversal with 4 Universal Buckets and plate carrier	71
12.2 Rotor S-4x750	73
12.2.1 Swing-bucket rotor S-4x750 with 4 750 mL round buckets	73
12.2.2 Swing-bucket rotor S-4x750 with 4 plate buckets	76
12.3 Rotor S-4x500	78
12.3.1 Swing-bucket rotor S-4x500 with 4 500 mL rectangular buckets	78
12.3.2 Swing-bucket rotor S-4x500 with 4 MTP/Flex buckets	80
12.4 Rotor S-4x400	82
12.5 Rotor FA-6x50	84
12.6 Rotor FA-20x5	86
12.7 Rotor FA-48x2	87
12.8 Rotor FA-30x2	88
12.9 Rotor F-48x15	89
13 Ordering information	91
13.1 Rotors and accessories	91
13.1.1 Rotor S-4xUniversal	91
13.1.2 Rotor S-4x750	91
13.1.3 Rotor S-4x500	92
13.1.4 Rotor S-4x400	92
13.1.5 Rotor FA-6x50	93
13.1.6 Rotor FA-20x5	93
13.1.7 Rotor FA-48x2	93
13.1.8 Rotor FA-30x2	94
13.1.9 Rotor F-48x15	94
13.2 Accessories	94
Index	95
Certificates	97

1 Operating instructions







1.1 Using this manual

- ▶ Read this operating manual completely before using the device for the first time. Also observe the instructions for use of the accessories.
- ▶ This operating manual is part of the product. Thus, it must always be easily accessible.
- ▶ Enclose this operating manual when transferring the device to third parties.
- ▶ You will find the current version of the operating manual for all available languages on our website under www.eppendorf.com/manuals.

1.2 Danger symbols and danger levels

1.2.1 Danger symbols


The safety instructions in this manual have the following danger symbols and danger levels:

	Biohazard		Explosive substances
	Electric shock		Risk of crushing
	Hazard point		Material damage

1.2.2 Danger levels

DANGER	<i>Will</i> lead to severe injuries or death.
WARNING	<i>May</i> lead to severe injuries or death.
CAUTION	May lead to light to moderate injuries.
NOTICE	May lead to material damage.

1.3 Symbols used

Depiction	Meaning
1. 2.	Actions in the specified order
▶	Actions without a specified order
•	List:
<i>Text</i>	Display or software texts
	Additional information

1.4 Abbreviations used

MTP

Microplate

PCR

Polymerase Chain Reaction – PCR

rcfRelative centrifugal force: g -force in m/s^2 **rpm**

Revolutions per minute

UV

Ultraviolet radiation

2 Safety

2.1 Intended use

The Centrifuge 5910 R is used for the separation of aqueous solutions and suspensions of different densities in approved sample tubes.

The Centrifuge 5910 R is exclusively intended for use indoors. All country-specific safety requirements for operating electrical equipment in the laboratory must be observed.

2.2 User profile

The device and accessories may only be operated by trained and skilled personnel.

Before using the device, read the operating manual carefully and familiarize yourself with the device's mode of operation.

2.3 Information on product liability

In the following cases, the designated protection of the device may be compromised. Liability for any resulting property damage or personal injury is then transferred to the operator:

- The device is not used in accordance with the operating manual.
- The device is used outside of its intended use.
- The device is used with accessories or consumables which are not recommended by Eppendorf.
- The device is maintained or repaired by people not authorized by Eppendorf.
- The user makes unauthorized changes to the device.

2.4 Application limits

2.4.1 Declaration concerning the ATEX directive (2014/34/EU)



DANGER! Risk of explosion.

- ▶ Do not operate the device in areas where work is completed with explosive substances.
 - ▶ Do not use this device to process any explosive or highly reactive substances.
 - ▶ Do not use this device to process any substances which could create an explosive atmosphere.
-

Due to its design and the environmental conditions inside the device, the Centrifuge 5910 R is not suitable for use in a potentially explosive atmosphere.

The device may only be used in a safe environment, such as in the open environment of a ventilated laboratory or a fume hood. The use of substances that may contribute to a potentially explosive atmosphere is not permitted. The final decision on the risks associated with the use of such substances lies with the user.

2.5 Warnings for intended use

2.5.1 Personal injury or damage to the equipment



WARNING! Electric shock due to damage to device or mains/power cord.

- ▶ Only switch on the device if the device and the mains/power cord are undamaged.
- ▶ Only use devices that have been properly installed or repaired.
- ▶ In case of danger, disconnect the device from the mains supply. Disconnect the mains/power plug from the device or the earth/grounded socket. Use the isolating device intended for this purpose (e.g., the emergency switch in the laboratory).



WARNING! Lethal voltages inside the device.

Touching parts which are under high voltage may cause an electric shock. An electric shock injures the heart and causes respiratory paralysis.

- ▶ Ensure that the housing is closed and undamaged.
- ▶ Do not remove the housing.
- ▶ Ensure that no liquid can penetrate into the device.

Only authorized service staff may open the device.



WARNING! Risk from incorrect voltage supply.

- ▶ Only connect the device to voltage sources which correspond with the electrical requirements on the name plate.
- ▶ Only use sockets with protective earth conductor.
- ▶ Only use the mains/power cord supplied.



WARNING! Damage to health due to infectious liquids and pathogenic germs.

- ▶ When handling infectious liquids and pathogenic germs, observe the national regulations, the biological security level of your laboratory, the safety data sheets, and the manufacturer's application notes.
- ▶ Use aerosol-tight sealing systems for the centrifugation of these substances.
- ▶ When working with pathogenic germs belonging to a higher risk group, more than one aerosol-tight bioseal must be used.
- ▶ Wear your personal protective equipment.
- ▶ Consult the "Laboratory Biosafety Manual" (source: World Health Organization, Laboratory Biosafety Manual, in its respectively current valid version).



WARNING! Risk of injury due to defective gas spring(s).

A defective gas spring is an insufficient support for the centrifuge lid. There is a risk of crushing fingers or limbs.

- ▶ Make sure that the centrifuge lid can be opened completely and that it will remain in this position.
- ▶ Regularly check all gas springs for their proper function.
- ▶ Have defective gas springs replaced immediately.
- ▶ Have gas springs replaced by a service technician every 2 years.



WARNING! Risk of injury from chemically or mechanically damaged accessories.

Even minor scratches and cracks can lead to serious internal material damage.

- ▶ Protect all accessory parts from mechanical damage.
- ▶ Inspect the accessories for damage before each use. Replace any damaged accessories.
- ▶ Do not use any accessories whose maximum service life has been exceeded.



CAUTION! Poor safety due to incorrect accessories and spare parts.

The use of accessories and spare parts other than those recommended by Eppendorf may impair the safety, functioning and precision of the device. Eppendorf cannot be held liable or accept any liability for damage resulting from the use of incorrect or non-recommended accessories and spare parts, or from the improper use of such equipment.

- ▶ Only use accessories and original spare parts recommended by Eppendorf.



NOTICE! Damage to device due to spilled liquids.

1. Switch off the device.
2. Disconnect the device from the power supply.
3. Carefully clean the device and the accessories in accordance with the cleaning and disinfection instructions in the operating manual.
4. If a different cleaning and disinfecting method is to be used, contact Eppendorf AG to ensure that the intended method will not damage the device.



NOTICE! Damage to electronic components due to condensation.

Condensate can form in the device after it has been moved from a cool environment to a warmer environment.

- ▶ After installing the device, wait for at least 4 h. Only then connect the device to the mains/power line.



NOTICE! Centrifuge 5910 R: Compressor damage after improper transport.

- ▶ Only switch on the centrifuge 4 hours after installation.

2.5.2 Incorrect handling of the centrifuge



NOTICE! Damage from knocking against or moving the device during operation.

If the rotor bangs against the rotor chamber wall, it will cause considerable damage to the device and rotor.

- ▶ Do not move or knock against the device during operation.
-

2.5.3 Incorrect handling of the rotors



WARNING! Risk of injury from improperly attached rotors and rotor lids.

- ▶ Only centrifuge with rotor and rotor lid firmly tightened.
 - ▶ If there are any unusual noises when the centrifuge is started up, the rotor or rotor lid may not be properly attached. Immediately press the **start/stop** key to stop centrifuging.
-



CAUTION! Risk of injury due to asymmetric loading of a rotor.

- ▶ Always load all positions of a swing-bucket rotor with buckets.
 - ▶ Load buckets symmetrically with identical tubes or plates.
 - ▶ Only load adapters with suitable tubes or plates.
 - ▶ Always use tubes or plates of the same type (weight, material/density and volume).
 - ▶ Check that loading is symmetrical by balancing the adapters and tubes or plates used with scales.
-



CAUTION! Risk of injury from overloaded rotor.

The centrifuge is designed for the centrifugation of material with a maximum density of 1.2 g/mL at maximum speed and filling volume and/or load.

- ▶ Do not exceed the maximum load of the rotor.
-



CAUTION! Risk of injury due to chemically damaged rotor lids or caps.

Transparent rotor lids or caps made of PC, PP or PEI may lose their strength under the impact of organic solvents (e.g., phenol, chloroform).

- ▶ If rotor lids or caps have come into contact with organic solvents, they must be cleaned immediately.
- ▶ Regularly check the rotor lids and caps for damage and cracks.
- ▶ Immediately replace rotor lids or caps that have cracks or milky stains.



NOTICE! Damage to rotors from aggressive chemicals.

Rotors are high-quality components which withstand extreme stresses. This stability can be impaired by aggressive chemicals.

- ▶ Avoid using aggressive chemicals, including strong and weak alkalis, strong acids, solutions with mercury, copper and other heavy metal ions, halogenated hydrocarbons, concentrated saline solutions and phenol.
- ▶ If the rotor is contaminated by aggressive chemicals, clean it immediately using a neutral cleaning agent. Clean the rotor bores in particular.
- ▶ Due to the manufacturing process, color variations may occur on rotors marked "coated". These color variations do not affect the service life or resistance to chemicals.



NOTICE! If handled incorrectly, the rotor can fall over.

The swing-bucket rotor may fall if the buckets are used as handles.

- ▶ Remove the buckets before inserting and/or removing a swing-bucket rotor.
- ▶ Always use both hands to carry the rotor cross.



NOTICE! If handled incorrectly, the rotor can fall over.

- ▶ Always pick up the rotor F-48x15 with both hands.
- ▶ In order to hold the rotor safely, possibly you have to remove 3 to 4 sleeves from the opposite outer row.



NOTICE! Buckets swinging out in the wrong direction.

If the wrong adapters are used for 500 mL Corning tubes, it might happen that the buckets of the swing-bucket rotor swing out in the wrong direction. This can lead to sample loss or damage of the centrifuge.

- ▶ Therefore, only use the Eppendorf adapters for 500 mL Corning tubes intended for this purpose.

2.5.4 Extreme strain on the centrifuging tubes



CAUTION! Risk of injury from overloaded tubes.

- ▶ Note the loading limits specified by the tube manufacturer.
- ▶ Only use tubes which are approved by the manufacturer for the required g -force (rcf).



NOTICE! Risk from damaged tubes.

Damaged tubes must not be used, as this could cause further damage to the device and the accessories and loss of the samples.

- ▶ Before use, visually check all of the tubes for damage.



NOTICE! Risk from open tube lids.

Open tube lids can brake off during centrifugation and damage the rotor and the centrifuge.

- ▶ Carefully seal all tube lids before centrifuging.



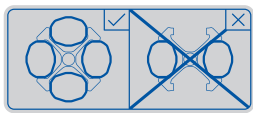



NOTICE! Hazard to plastic tubes from organic solvents.

The density of plastic tubes is reduced when organic solvents (e.g., phenol, chloroform) are used, i.e. the tubes could become damaged.

- ▶ Note the manufacturer's information on the chemical resistance of the tubes.

2.6 Safety instructions on the device and accessories

Depiction	Meaning	Location
	CAUTION ▶ Observe the safety instructions in the operating manual.	Right side of the device
	▶ Observe operating manual.	Right side of the device
	▶ Always load all 4 positions of the swing-bucket rotor with buckets.	Inside of the centrifuge lid
	Warning of biological risks when handling infectious liquids or pathogenic germs.	Aerosol-tight fixed-angle rotors: Rotor lid Aerosol-tight buckets: Cap

3 Product description

3.1 Product overview

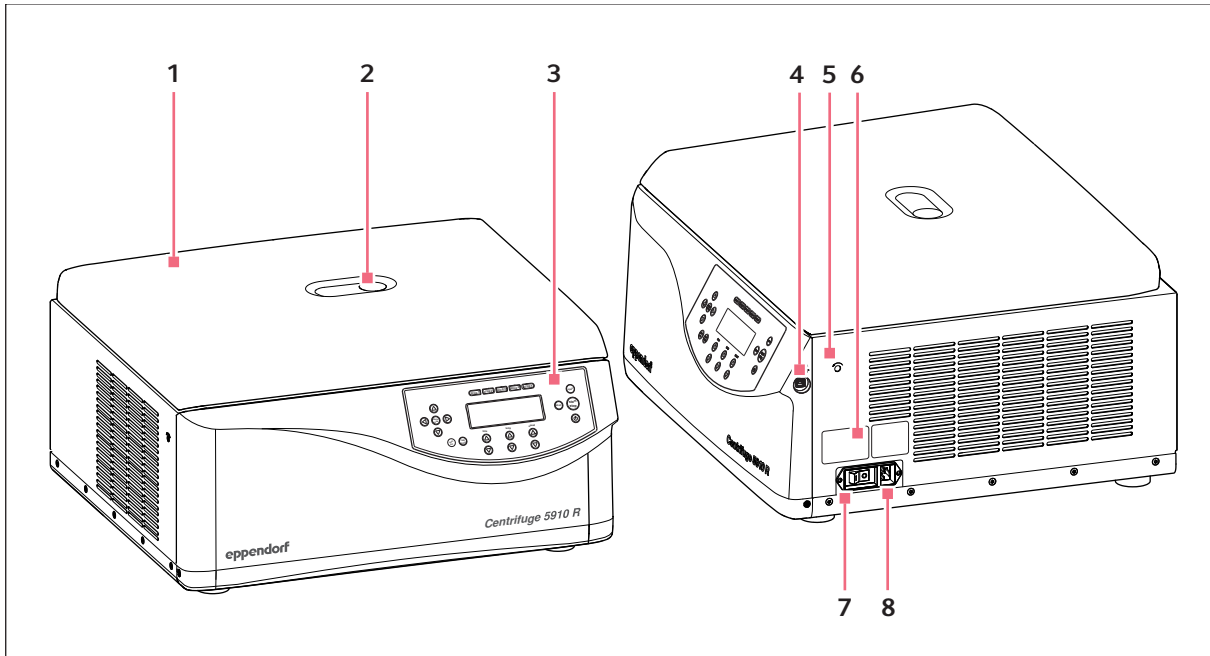


Fig. 3-1: Centrifuge 5910 R: Front and side view

- | | |
|--|---|
| <p>1 Centrifuge lid</p> | <p>5 Emergency release</p> |
| <p>2 Monitoring glass
Visual control for rotor stop or speed control option using stroboscope</p> | <p>6 Name plate</p> |
| <p>3 Control panel
Display and keys for operating the centrifuge.</p> | <p>7 Mains/power switch
Switch for switching the centrifuge on and off.</p> |
| <p>4 USB interface
Only for Technical Service: interface for software updates.</p> | <p>8 Mains/power cord socket
Connection for the mains/power cord supplied.</p> |

Product description

Centrifuge 5910 R
English (EN)

3.2 Delivery package

1	Centrifuge 5910 R see <i>Ordering information</i> chapter for the corresponding device version, equipment and order numbers
1	Rotor key
1	Mains/power cord
1	Operating manual



- ▶ Check the delivery for completeness.
- ▶ Inspect all items for damage that may have occurred during delivery.
- ▶ To safely transport and store the device, keep the transport box and packing material.

3.3 Features

The versatile Centrifuge 5910 R has a capacity of up to 4 × 750 mL and reaches a maximum of 22 132 × *g* or 14 000 rpm. You can select from a wide variety of rotors to centrifuge the following tubes for various applications:

- Micro test tubes (0.2 mL to 5.0 mL)
- Microtainers
- Spin columns
- Cryogenic tubes
- Conical tubes (15 mL, 50 mL)
- Bottles (175 mL to 750 mL)
- Microplates
- PCR plates
- Deepwell plates
- Slides (with CombiSlide adapter)
- Blood collection systems

Handling the centrifuge is facilitated by:

- Automatic rotor detection with rotational speed limit
- Automatic rotor imbalance detection
- Clear digital display

The centrifuge has 99 program slots for user-defined settings and 10 different acceleration and braking ramps.

The possibility of setting the radius manually ensures maximum rcf accuracy.

The Centrifuge 5910 R also features a temperature control function for centrifuging at temperatures from -11 °C to 40 °C. Use the **FastTemp** function to start a temperature control run without samples to bring the rotor chamber incl. rotor, buckets and adapters to the set target temperature quickly. Continuous cooling also maintains the temperature in the rotor chamber with the centrifuge lid closed when the centrifuge is not in use.

3.4 Name plate

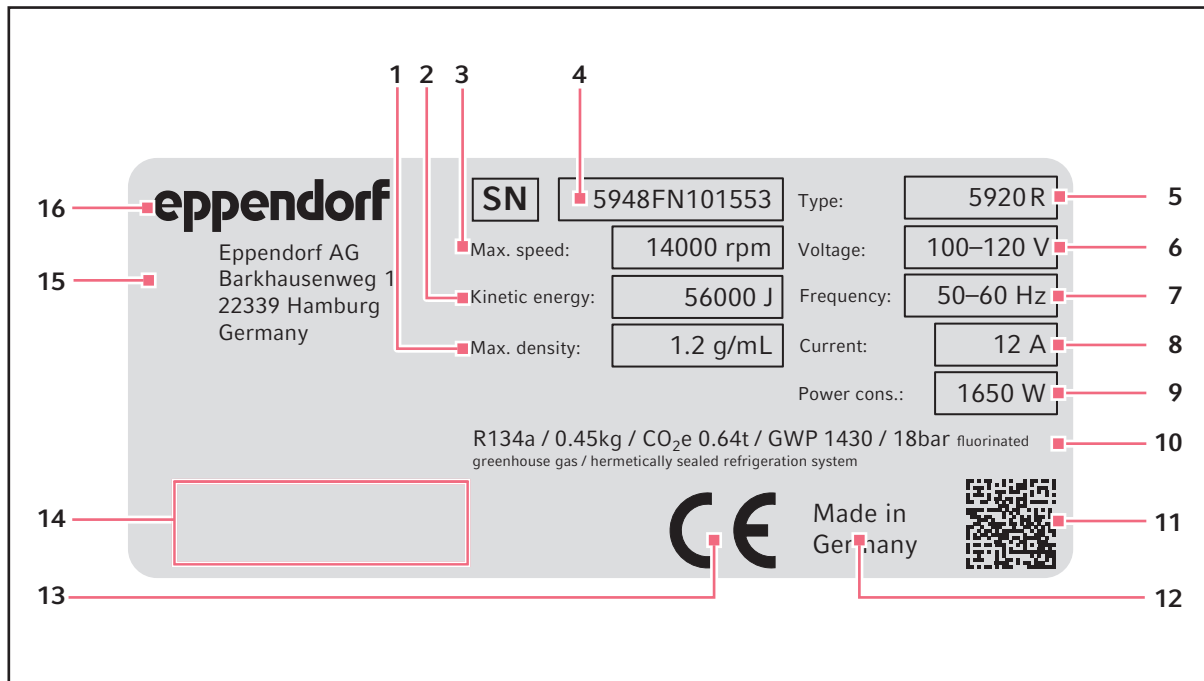




Fig. 3-2: Eppendorf AG device identification (example)

- | | |
|---|--|
| 1 Maximum density of the material for centrifuging | 9 Power consumption |
| 2 Maximum kinetic energy | 10 Information on the refrigerant (refrigerated centrifuges only) |
| 3 Maximum speed | 11 Data matrix code for serial number |
| 4 Serial number | 12 Designation of origin |
| 5 Product name | 13 CE marking |
| 6 Permitted voltage | 14 Certification marks and symbols (device-specific) |
| 7 Permitted frequency | 15 Address of manufacturer |
| 8 Current consumption | 16 Manufacturer |

Product description

Centrifuge 5910 R
English (EN)

Tab. 3-1: Certification marks and symbols (device-specific)

Symbol/Approval mark	Meaning
	Serial number
	Symbol for waste electrical and electronic equipment (WEEE) according to EU Directive 2012/19/EU, European Community
	UL mark: declaration of conformity, USA
	Conformity mark for electromagnetic compatibility according to the Federal Communications Commission, USA
	"China RoHS" conformity mark (Requirements for Concentration Limits for Certain Hazardous Substances in Electronic Information Products SJ/T 11363-2006), People's Republic of China

4 Installation

4.1 Selecting the location



WARNING! Risk of fire.

Due to the high current consumption of the centrifuge, an overload may occur if the network is not secure.

- ▶ Only connect the centrifuge to an electric circuit that has its own protection.
- ▶ Do not connect any devices to the circuit other than the centrifuge.
- ▶ Only use the mains/power cord supplied.



NOTICE! If an error occurs, the objects in the immediate proximity of the device will be damaged.

- ▶ In accordance with the recommendations of EN 61010-2-020, leave a safety clearance of **30 cm** around the device during operation.
- ▶ Please remove all materials and objects from this area.



NOTICE! Damage from overheating.

- ▶ Do not place the device near heat sources (e.g., heating, drying cabinet).
- ▶ Do not expose the device to direct sunlight.
- ▶ Ensure unobstructed air circulation. Maintain a clearance of at least 30 cm (11.8 in) around all ventilation gaps.



NOTICE! Radio interference.

This device is a category A product in accordance with EN 55011. There may be disturbance to radio reception in residential areas.

- ▶ Ensure that appropriate preventive measures are taken.



Mains/power connection for centrifuges: Operation of the centrifuge is only permitted at a building installation corresponding to the national regulations and standards. It must in particular be ensured that there is no inadmissible load on supply lines and assemblies which are located upstream of the internal protection of the device. This can be ensured by additional circuit breakers or other suitable safety elements in the building installation.



The mains/power switch and cutting unit of the mains/power line must be easily accessible during operation (e.g., residual current circuit breaker).

- ▶ Select the location of the device according to the following criteria:
 - Mains/power connection in accordance with the name plate.
 - Minimum distance to other devices and walls: 30 cm (11.8 in).
 - A resonance-free bench with a horizontal and even work surface which is designed to support the weight of the device.
 - The location has good ventilation.
 - The location is protected against direct sunlight.
- ▶ Do not use the device near sources of strong electromagnetic radiation (e.g., unshielded high-frequency sources) because they can interfere with proper operation.

4.2 Preparing installation

The weight of the centrifuge is 109.0 kg (240.3 lb).



CAUTION! Risk of injury when lifting and carrying heavy loads

- ▶ Use a lifting aid when installing the device.

Unpacking the centrifuge

1. Loosen the straps.
2. Lift the carton upward and remove it.
3. Remove accessories.
4. Remove the transport securing devices.
5. Remove the plastic sleeve.
6. Lift the centrifuge using a suitable mechanical lifting aid.
7. Place the device on a suitable lab bench.

4.3 Installing the instrument

Prerequisites

The device is on a suitable lab bench.



WARNING! Risk from incorrect voltage supply.

- ▶ Only connect the device to voltage sources which correspond with the electrical requirements on the name plate.
- ▶ Only use sockets with protective earth conductor.
- ▶ Only use the mains/power cord supplied.



NOTICE! Damage to electronic components due to condensation.

Condensate can form in the device after it has been moved from a cool environment to a warmer environment.

- ▶ After installing the device, wait for at least 4 h. Only then connect the device to the mains/power line.



NOTICE! Centrifuge 5910 R: Compressor damage after improper transport.

- ▶ Only switch on the centrifuge 4 hours after installation.

1. Let the device warm up to ambient temperature.
2. Connect the centrifuge to the mains/power line and switch it on at the mains/power switch.
 - The LED next to the **Standby** Ⓢ key lights up.
 - The display is active.
3. Open the centrifuge lid with the **open** key.

5 Operation

5.1 Operating controls

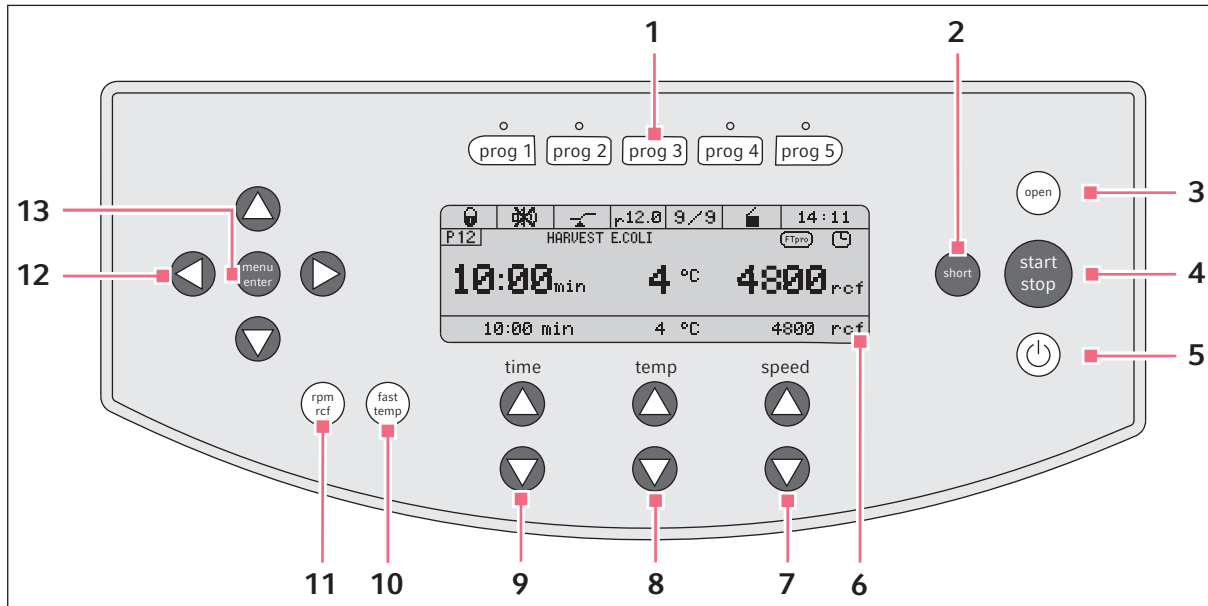



Fig. 5-1: Operating controlsCentrifuge 5910 R

- | | |
|---|---|
| <p>1 Program keys
Press the program key: Load program
Keep the program key pressed for 2 s: Save current parameters</p> | <p>8 Arrow keys temp
Setting the temperature
Keep the arrow key pressed: Quick setting</p> |
| <p>2 short key
Short spin centrifugation</p> | <p>9 Arrow keys time
Set centrifugation time
Keep the arrow key pressed: Quick setting</p> |
| <p>3 open key
Release lid</p> | <p>10 fast temp key
Start FastTemp temperature control run</p> |
| <p>4 start/stop key
Start and stop centrifugation</p> | <p>11 rpm/rcf key
Switch display of centrifugation speed (rpm or rcf)</p> |
| <p>5 Standby  key
Activate/deactivate standby mode
Key lights up green: centrifuge is ready for operation.
Key lights up red: standby mode is active.</p> | <p>12 Menu arrow keys
Navigate the menu</p> |
| <p>6 Display</p> | <p>13 menu/enter key
Open menu
Confirm your selection</p> |
| <p>7 Arrow keys speed
Set centrifugation speed
Keep the arrow key pressed: Quick setting</p> | |

Operation

Centrifuge 5910 R
English (EN)

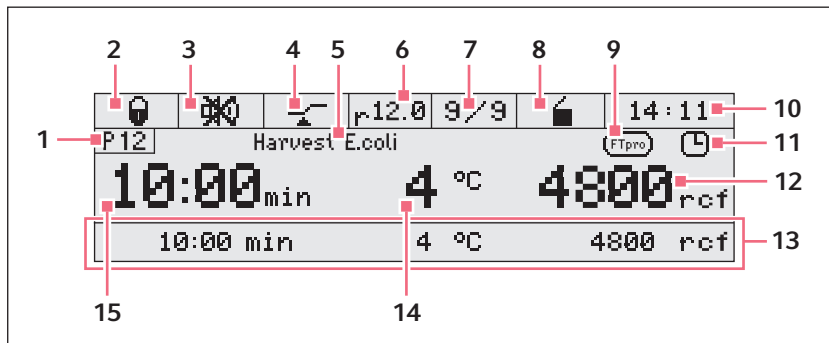


Fig. 5-2: Display Centrifuge 5910 R

1 Program number

2 Key lock

- 🔒 Key lock activated: Parameters cannot be changed.
- 🔓 No key lock.

3 Speaker

- 🔊 Speaker switched on.
- 🔇 Speaker switched off.

4 At set rpm function

- 📉: the set run time will be counted down when 95 % of the specified *g*-force (rcf) or speed (rpm) has been reached.
- 📈: time counting begins immediately.

5 Program name

6 Radius

7 Ramps

Accelerating and braking of the rotor.

8 Status of centrifuge

- 🔒 centrifuge lid unlocked.
- 🔒 centrifuge lid locked.
- 🔄 (flashing): centrifuging in progress.

9 FastTemp pro

🔒 FastTemp pro has been enabled. The start time and the temperature of the temperature control run are programmed.

10 Time

11 Timer

🕒 Timer set: delayed start (in programs only).

12 *g*-force (rcf) or speed (rpm)

Actual value

13 Set value row

Set values for centrifugation time, temperature, centrifugation speed. Visible, if *Extended display* has been enabled in the settings.


14 Temperature

Actual value

15 Centrifugation time


Actual value

5.2 Switching on the centrifuge


1. Switch on the centrifuge using the mains power switch or the **Standby**  key.
The parameter settings of the last run are displayed.
2. Press the **open** key to open the closed centrifuge lid.

5.3 Initial steps

5.3.1 Setting the menu language

1. Open menu: press the **menu/enter** key.
2. Use the menu arrow keys to select *Settings*. Confirm with the **menu/enter** key.
3. Use the menu arrow keys to select *Language*. Confirm with the **menu/enter** key.
4. Use the menu arrow keys to select *Deutsch, Francais, English* or *Espanol*. Confirm with the **menu/enter** key.
A checkmark appears in front of the selected language. The setting takes effect immediately.
5. To exit the menu, press the left menu arrow key  several times.

5.3.2 Setting date and time

1. Open menu: press the **menu/enter** key.
2. Use the menu arrow keys to select *Settings*. Confirm with the **menu/enter** key.
3. Use the menu arrow keys to select *Date/Time*. Confirm with the **menu/enter** key.
4. Use the menu arrow keys to select *International Time* or *US-Time (AM/PM)*. Confirm with the **menu/enter** key.
5. Set the date and time with the menu arrow keys. Confirm with the **menu/enter** key.
6. To exit the menu, press the left menu arrow key  several times.



The time does not change automatically from summer time to winter time.

5.4 Replacing the rotor



NOTICE! If handled incorrectly, the rotor can fall over.

The swing-bucket rotor may fall if the buckets are used as handles.

- ▶ Remove the buckets before inserting and/or removing a swing-bucket rotor.
- ▶ Always use both hands to carry the rotor cross.

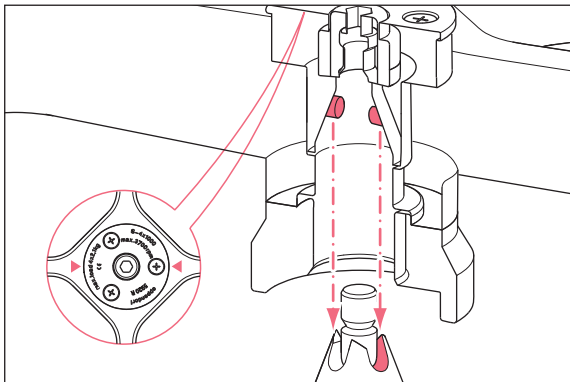


NOTICE! Material damage due to improper rotor insertion.

The motor shaft or bearing may get damaged if the rotor falls into the motor shaft guides in an uncontrolled manner during insertion.

- ▶ Hold the rotor with both hands.
- ▶ Guide the rotor onto the motor shaft.

5.4.1 Inserting the rotor



1. Place the rotor vertically onto the motor shaft from the top.
The arrows on the rotor show the position of the pegs. The pegs of the rotor must fit into the motor shaft guides. If required, lift the rotor and place it onto the motor shaft again.
2. Insert the rotor key supplied into the rotor nut.
3. Turn rotor key **clockwise** until the rotor nut is firmly tightened.

5.4.2 Removing the rotor

1. Turn the rotor nut **counterclockwise** using the rotor key supplied.
2. Remove rotor by lifting it vertically.

5.4.3 Triggering rotor detection



CAUTION! Risk of injury when turning the rotor manually.

- ▶ When turning a swing-bucket rotor, pay special attention to ensure that your fingers do not get jammed or get caught on the swinging buckets.

The centrifuge detects a newly inserted rotor if the rotor is moved at low speed.

- ▶ In order to trigger rotor detection manually, turn the rotor **counterclockwise** by hand.
 - The name of the rotor appears in the display.
 - If the g -force (rcf) or speed (rpm) has been set higher, it will be limited to the maximum value of the rotor.



Triggering rotor detection using short-spin centrifugation

- ▶ Press and hold the **short** key until the name of the rotor appears on the display.

If you start centrifuging immediately after a rotor change, then the centrifuge has not yet detected the new rotor. If the set g -force/speed is higher than the maximum permitted g -force/speed of the new rotor, the following message appears in the display:

```
rpm/rcf too high!  
[START] Centrifugation at ### rpm/### rcf  
◀ ▶ Change parameters.
```

- The message shows the maximum permitted g -force/speed of the new rotor.
 - The rotor is not stopped, but it is held at a speed of 700 rpm.
 - You have 15 seconds to adopt the g -force/speed or to change it.
- ▶ Adopt the displayed g -force/speed for the run: Press the **start/stop** key.
 - ▶ To change the g -force or speed for the run: use the arrow keys **speed** to set a different value.

If you do not adopt or change the g -force/speed within 15 s, the centrifuge will stop running. The display shows the error message *Hint C*.



- ▶ After each rotor change, check whether the new rotor is detected by the device.
- ▶ Check the set g -force (rcf) and/or speed (rpm) and adjust it, if required.

5.5 Loading a fixed-angle rotor



CAUTION! Risk of injury due to asymmetric loading of a rotor.

- ▶ Load rotors symmetrically with identical tubes.
- ▶ Only load adapters with suitable tubes.
- ▶ Always use the same type of tubes (weight, material/density and volume).
- ▶ Check symmetric loading by balancing the adapters and tubes used with scales.

1. Check the maximum payload (adapter, tube and contents) for each rotor bore.
2. Load rotors and adapters only with the tubes intended for them.
3. To ensure symmetrical loading, insert sets of two tubes in opposite bores. Tubes located opposite each other must be of the same type and contain the same filling quantity.

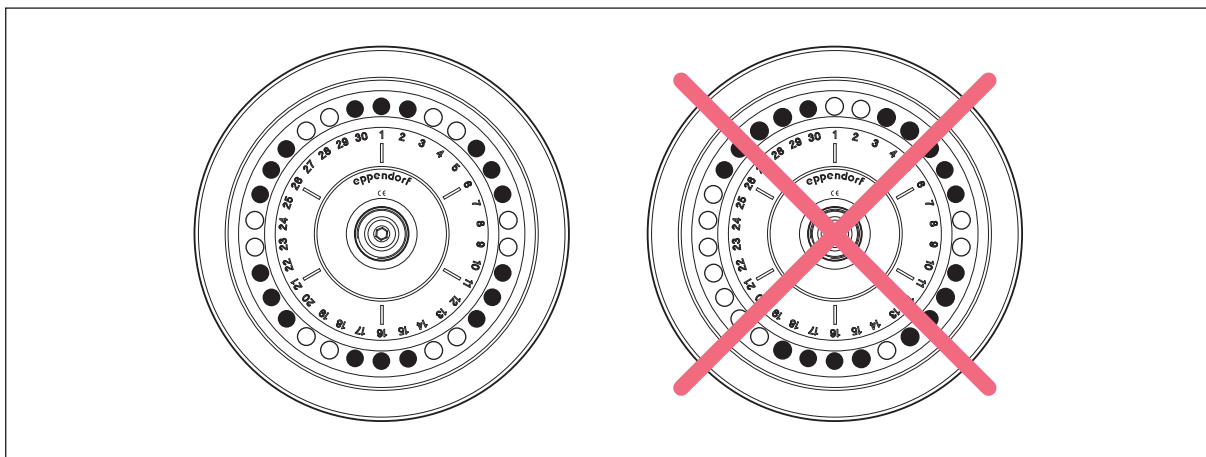


Fig. 5-3: Symmetrical loading of a fixed-angle rotor

To keep the weight differences between the filled tubes low, we recommend taring with a balance. This will reduce wear on the drive and reduce operating noise.

5.5.1 Closing the rotor lid



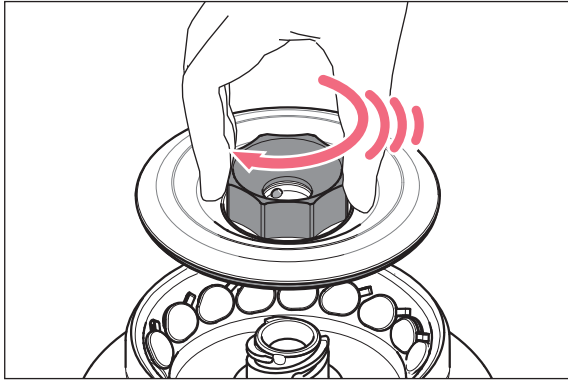
Use matching rotor lids

- Fixed-angle rotors may only be operated with the appropriate rotor lid in each case. The rotor name on the rotor must correspond to the rotor name on the rotor lid.
- To carry out an aerosol-tight centrifugation, an aerosol-tight rotor (label: **red ring**) and the corresponding aerosol-tight rotor lid (label: **aerosol-tight** and **red lid screw**) must be used.

1. Fit the rotor lid vertically onto the rotor.
2. Turn the rotor lid screw clockwise to seal the rotor.

5.5.2 Closing the QuickLock rotor lid

Aerosol-tight rotors have a QuickLock rotor lid.



1. Check the correct positioning of the external sealing ring in the groove.
2. Place the rotor lid on the rotor in a vertical motion.
3. To lock the rotor, turn the red rotor lid screw clockwise as far as it will go, and after an audible "click" is heard.



The rotor is correctly locked after the audible "click" is heard!

5.6 Loading the swing-bucket rotor



CAUTION! Risk of injury due to asymmetric loading of a rotor.

- ▶ Always load all positions of a swing-bucket rotor with buckets.
- ▶ Load buckets symmetrically with identical tubes or plates.
- ▶ Only load adapters with suitable tubes or plates.
- ▶ Always use tubes or plates of the same type (weight, material/density and volume).
- ▶ Check that loading is symmetrical by balancing the adapters and tubes or plates used with scales.



NOTICE! Material damage due to incomplete loading of the swing-bucket rotor.

Incomplete loading of the swing-bucket rotor reduces the rotor's service life.

- ▶ Always load all positions of a swing-bucket rotor with buckets.

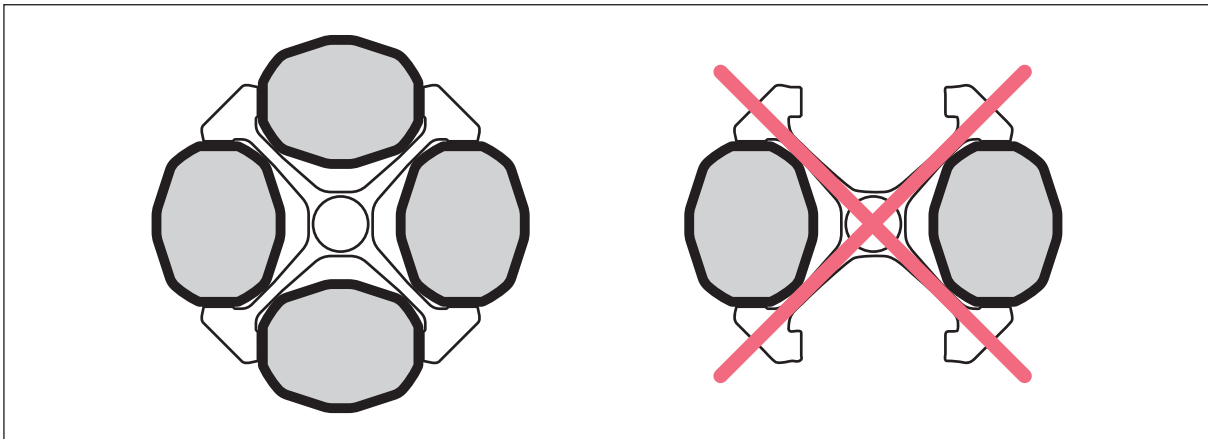


Fig. 5-4: Swing-bucket rotors: Loading all positions with buckets

5.6.1 Inserting the bucket in the swing-bucket rotor

Prerequisites

- The combination of rotor, bucket and adapter has been approved by Eppendorf.
- Buckets that are located opposite each other belong to the same weight class. The weight class is engraved in the sides of the groove: e.g., 68.
- Matching and tested tubes and plates.



The swing-bucket rotor runs more smoothly if all buckets are loaded symmetrically with the same weight.

- ▶ To reduce noise and vibrations, load the buckets of the swing-bucket rotor with the same weight.

1. Check that the bucket grooves are clean. Use pivot grease to lightly lubricate the grooves.

2. Hang the buckets into the rotor.

All rotor positions must be equipped with buckets.

3. Check to see if all buckets are completely hung and can freely swing out.

4. Check the maximum load per bucket (adapter, vessel or plate and contents) and the loading height.

5. Load the buckets symmetrically.



- ▶ When using a vessel type or plate type for the first time, carry out a brief test run at low speed (e.g., 1000 rpm).

5.6.2 Performing an imbalance calibration

Carry out a manual imbalance calibration when you use a tube or plate for the first time. Always carry out a manual imbalance calibration when you use tubes with a length of > 100 mm.

- ▶ Inserting plates and/or tubes.
- ▶ Swing the buckets manually up to 90°.
 - Bucket swings freely.
 - The tubes do not touch the rotor cross.

5.6.3 Loading buckets symmetrically

5.6.3.1 Equipping buckets with vessels

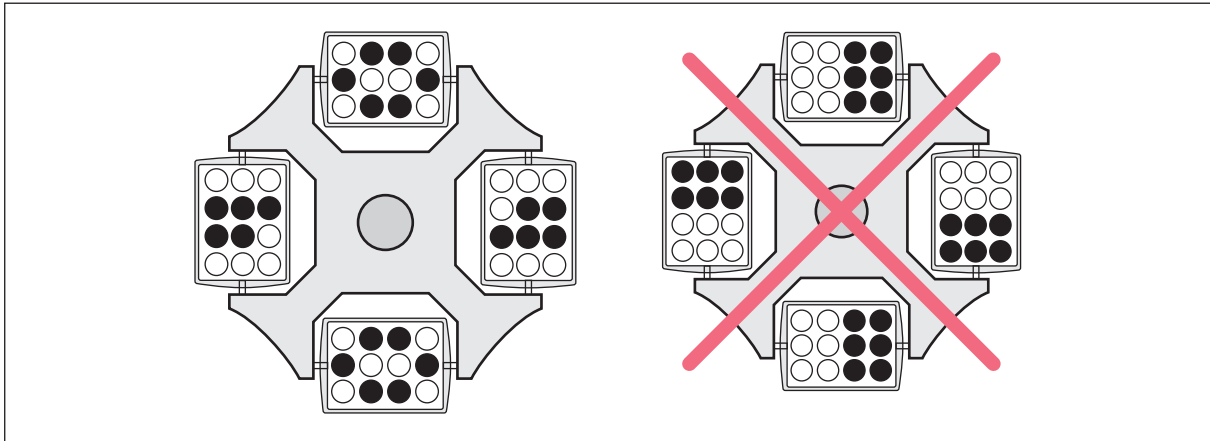


Fig. 5-5: Swing-bucket rotors: Incomplete, but symmetric loading of the buckets.

The loading shown on the right-hand side is incorrect as it places an uneven load on the pegs of the rotor.

- ▶ To reduce vibrations and noise, load all buckets of the swing-buckets rotor equally.

5.6.3.2 Loading plates symmetrically



NOTICE! Filling the plates too high can cause overflowing.

During the run the menisci in the tubes along the edges of the plates are at an angle. This is due to the centrifugal forces and cannot be avoided.

- ▶ Fill the plate wells to a maximum of $\frac{2}{3}$ of the maximum filling volume.

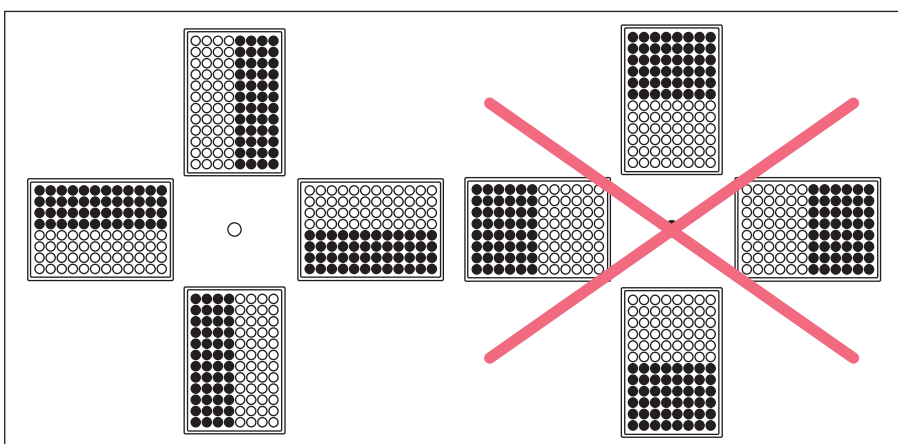


Fig. 5-6: Swing-bucket rotors: Symmetrical loading of plates

- ▶ In order to avoid imbalances, always load the plates symmetrically.

The plate loading shown on the right-hand side is incorrect as the plate buckets will not swing properly if loaded in this way.

5.6.3.3 Rotor S-4x750: Equipping the adapter with vessels > 119 mm

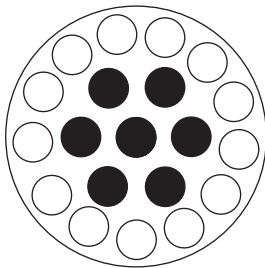


NOTICE! Broken glass due to incorrect loading.

If the tubes in a bucket are too long, the swinging tubes will touch the rotor cross and may get damaged or destroyed.

- ▶ Load buckets such that they can swing out freely.
- ▶ If necessary, load only the inner bores of the adapter.
- ▶ If using tubes longer than 100 mm: always perform a manual swing test.

If the adapter 16 × 75 mm – 100 mm (order number 5825 736.001) is equipped with vessels > 119 mm, e.g., BD 8 mL Vacutainer, this will result in danger of glass breakage.



- ▶ Only equip the inner bores.

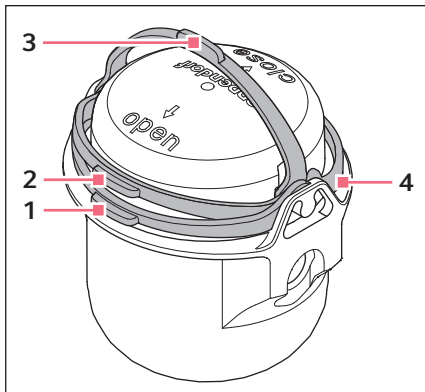
5.6.4 Closing the bucket with the cap



NOTICE! Damage to the cap hook.

If the cap is not fitted correctly on the bucket, the sealing clamp may break during closing.

- ▶ Before you fold the sealing clamp, check that the cap is positioned correctly.



1. Fold the cap clamp to the **open** position (1).
2. Place the cap on the bucket and push the cap down in such a way that the clamp is lifted slightly (2).
3. To transport the bucket, fold the clamp to the carrying position (3).
4. To seal the bucket so that it is aerosol-tight, fold the clamp beyond the latch into the **close** position.
The clamp has only been folded correctly if there is an audible *click* (4).

5.6.5 Mixed equipping with different buckets

Mixed equipping of swing-bucket rotors with different buckets is possible if these are intended for the rotor. Buckets that are located opposite each other must be of the same type.

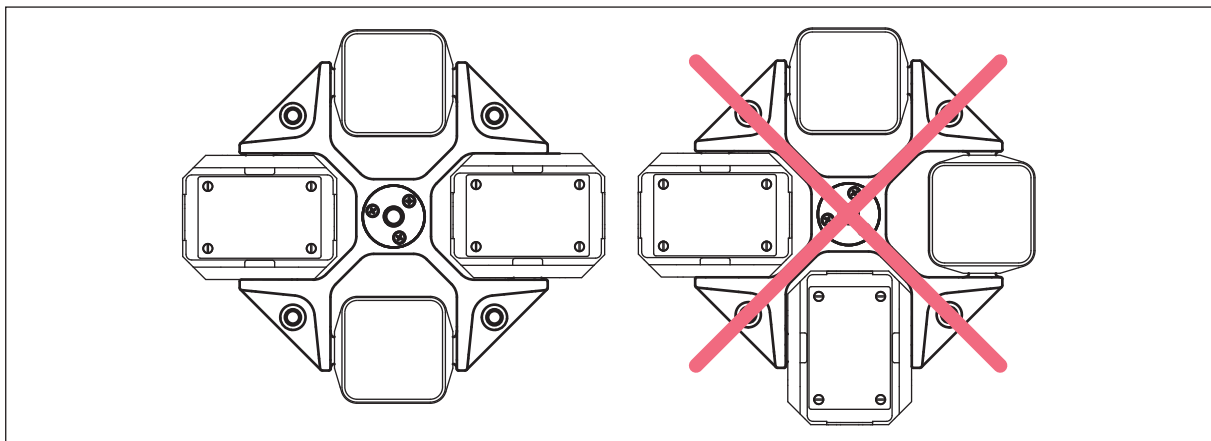


Fig. 5-7: Mixed equipping of a swing-bucket rotor

5.7 Closing the centrifuge lid



WARNING! Risk of injury when opening or closing the centrifuge lid.

There is a risk of crushing your fingers when opening or closing the centrifuge lid.

- ▶ When opening or closing the centrifuge lid, do not reach between the lid and device or into the latching mechanism of the lid.
 - ▶ Always open the centrifuge lid completely to prevent it from falling.
-

1. Check that the rotor is attached correctly.
2. Press the centrifuge lid down until it is gripped by the lid latch. The lid will be closed automatically.
 - The LED next to the **open** key lights up in blue.
 - The ■ symbol appears on the display.

5.8 Aerosol-tight centrifugation



WARNING! Risk to health due to limited aerosol tightness with incorrect rotor/rotor lid combination.

Aerosol-tight centrifugation is guaranteed only if the rotors and rotor lids intended for this purpose are used. The designation of aerosol-tight fixed-angle rotors always starts with **FA**. The aerosol-tight rotors and rotor lids of this centrifuge are additionally marked with a red ring on the rotor and a red rotor lid screw.

Aerosol-tight swing-bucket rotors are marked **AT** (aerosol-tight).

- ▶ Always use rotors and rotor lids marked aerosol-tight together for aerosol-tight centrifugation. The details specifying in which centrifuge you may use the aerosol-tight rotors and rotor lids can be found on the rotor and on the upper side of the rotor lid.
- ▶ Only use aerosol-tight rotor lids in combination with rotors which are marked on the rotor lid.
- ▶ Only use aerosol-tight buckets with the corresponding caps.



WARNING! Health hazard from limited aerosol-tightness due to incorrect use.

Autoclaving, mechanical stresses and contamination with chemicals or other aggressive solutions can impair the aerosol tightness of the rotors and rotor lids.

- ▶ Check the integrity of the seals of the aerosol-tight rotor lids or caps before each use.
- ▶ Only use aerosol-tight rotor lids or caps if the seals are undamaged and clean.
- ▶ Lightly grease the threads of the rotor lid screw with pivot grease after every proper autoclaving (121 °C, 20 min.). (Order no. Int. 5810 350.050, North America 022634330).
- ▶ Replace aerosol-tight rotor lids after 50 autoclaving cycles.
- ▶ For QuickLock rotor lids, the seal must be replaced after 50 autoclaving cycles.
- ▶ Replace aerosol-tight rotor caps after 50 autoclaving cycles.
- ▶ **Never** store aerosol-tight rotors or buckets closed.



The aerosol tightness of rotors, rotor lids, buckets and caps has been tested and certified according to Annex AA of IEC 61010-2-020.

5.8.1 Aerosol-tight centrifugation in a fixed-angle rotor

Aerosol-tight fixed-angle rotors have a QuickLock rotor lid.

- ▶ Replace the seals of QuickLock rotor lids after 50 autoclaving cycles.
- ▶ Replace damaged seals of QuickLock rotor lids.

5.8.2 Aerosol-tight centrifugation in a swing-bucket rotor

- ▶ For aerosol-tight centrifugation in a swing-bucket rotor, use buckets with aerosol-tight caps.
- ▶ Replace aerosol-tight caps after 50 autoclaving cycles.

5.9 Centrifugation

Prerequisites

- The centrifuge is switched on.
- The rotor has been inserted and attached correctly.
- The rotor has been loaded correctly.
- The rotor lid has been mounted correctly.
- Buckets can swing out freely.
- The centrifuge lid is closed.



WARNING! Risk of injury from improperly attached rotors and rotor lids.

- ▶ Only centrifuge with rotor and rotor lid firmly tightened.
- ▶ If there are any unusual noises when the centrifuge is started up, the rotor or rotor lid may not be properly attached. Immediately press the **start/stop** key to stop centrifuging.

5.9.1 Centrifugation with time setting

Setting the centrifugation parameters


1. Set the centrifugation time with the **time** arrow keys.
2. Set the temperature with the **temp** arrow keys.
3. Set the rotational speed (rpm) or *g*-force (rcf) with the **speed** arrow keys.

If the speed is set via the *g*-force (rcf): check the radius (see *Setting the radius on p. 37*).

Starting the centrifugation run

4. To start the centrifugation run, press the **start/stop** key.

Display during centrifugation


-  flashes in the display when the rotor is running.
- Remaining run time in minutes. The last minute is counted down in seconds.
- Current temperature in the rotor chamber.
- Current *g*-force (rcf) and/or speed (rpm).
- Target values for centrifugation time, temperature and centrifugation speed in the target value row (if activated).



During the run you can change the following parameters:

- Centrifugation time: The shortest new run time that can be set must be 2 min above the elapsed time.
 - Temperature
 - Speed
- During the run you can switch between the display of the *g*-force and the speed, using the **rpm/rcf** key.
- Radius
 - Acceleration ramp/braking ramp

The following keys are blocked during centrifugation:


- **Standby**  key
- **open** key
- **short** key
- **prog 1** to **prog 5** program keys

5.9.2 End of centrifugation

- ▶ Press the **start/stop** key to end centrifugation before the set time.
- After completion of the set time, the centrifuge stops automatically.
- During the braking process, the elapsed running time flashes on the display.
- The signal sounds when the rotor is stopped.
- Time counter after rotor stop: A window on the display counts the time from the rotor stop to 10:00 h. Additionally, > 10:00 h is displayed.
- The LED of the **open** key flashes. The centrifuge lid remains sealed. Press the **open** key to open the lid.

5.9.3 Centrifuging in continuous operation

Setting up a continuous run


1. In order to centrifuge without any time limits, use the **time** arrow keys to select the setting ∞ (\blacktriangledown below 10 s or \blacktriangle above 99:59 h).
2. Set the temperature with the **temp** arrow keys.
3. Set the rotational speed (rpm) or *g*-force (rcf) with the **speed** arrow keys.
If the speed is set via the *g*-force (rcf): check the radius (see *Setting the radius* on p. 37).
4. To start the centrifugation run, press the **start/stop** key.
 -  flashes in the display when the rotor is running.
 - The cycle time is counted up.
 - Current temperature in the rotor chamber.
 - Current *g*-force (rcf) and/or speed.
5. Press the **start/stop** key to end the centrifugation.
 - During the braking process, the elapsed running time flashes on the display.
 - The signal sounds when the rotor is stopped.
6. Press the **open** key to open the lid.

5.9.4 Short spin centrifugation

Setting in the menu item *Short spin*:

- *Maximum speed*: Short spin centrifugation at the maximum speed of the inserted rotor.
- *Current speed*: Short spin centrifugation at a freely selected speed.

The short spin centrifugation runs as long as the **short** key is pressed.

1. For short-spin centrifugation with *Current speed* only: Set the rotational speed (rpm) or *g*-force (rcf) with the **speed** arrow keys.
2. Set the temperature with the **temp** arrow keys.
3. Press and hold the **short** key to start short-spin centrifugation.
 -  flashes in the display when the rotor is running.
 - All other keys are disabled during short spin centrifugation.
4. To end short run centrifugation, release the **short** key.
During the braking process, the elapsed running time flashes on the display.
5. Press the **open** key to open the lid.



The set acceleration ramp/braking ramp is disabled during short run centrifugation.

5.9.5 Setting the radius

Prerequisites

The centrifuge has detected the rotor.

The value for the radius is set to the maximum radius of the rotor.

As a standard, the conversion from speed to *g*-force is based on the biggest radius of the rotor. If you are using an adapter for tubes, you can adjust the value for the radius manually. You can find the value for the radius of an adapter in a rotor in the Technical data of the rotor.

1. Press the **menu/enter** key. Use the menu arrow keys to select *Radius*. Confirm with the **menu/enter** key.



The display shows the maximum radius of the rotor and the *g*-force (rcf) in accordance with the set speed.

2. Use the menu arrow keys ◀ or ▶ to set the radius for the adapter.
The *g*-force (rcf) is adjusted to the value of the radius.
3. Select *Save* with the menu arrow keys ◀ or ▶. Confirm with the **menu/enter** key.
4. To exit the menu, press the left menu arrow key ◀ several times.

5.9.6 Setting the acceleration ramp and braking ramp

You can set the acceleration and deceleration times in levels from 0 to 9.

- Level 9: shortest acceleration time/deceleration time (setting on delivery).
- Level 0: longest acceleration time/deceleration time.

1. Press the **menu/enter** key. Use the menu arrow keys to select *Ramps*. Confirm with the **menu/enter** key.
2. Use the menu arrow keys ▲ or ▼ to select *Accel. ramp ↗* or *Braking ramp ↘*.
3. Use the menu arrow keys ◀ or ▶ to select the level.
4. Select *Save* with the menu arrow keys ◀ or ▶. Confirm with the **menu/enter** key.

5.9.7 Setting the start of time counting (*At set rpm* function)

You can specify when time counting should begin:

- Time counting begins immediately: *At set rpm > Off ↯* (setting on delivery).
- Time counting starts when 95 % of the speed has been reached: *At set rpm > On ↲*

1. Press the **menu/enter** key. Use the menu arrow keys to select *At set rpm*. Confirm with the **menu/enter** key.
2. Use the menu arrow keys ▲ or ▼ to select *Off ↯* or *On ↲*. Confirm with the **menu/enter** key.
The display shows ↯ or ↲.

5.10 Cooling

The centrifuge cools or maintains the set temperature if the following requirements are met:

- The centrifuge is switched on.
- The centrifuge lid is closed.
- Only during continuous cooling: The set temperature is lower than the ambient temperature.



- The temperature that can actually be reached depends on the rotor and the set rotational speed.
- If the rotor stops (continuous cooling), cooling is slower than during centrifugation or a temperature control run.

5.10.1 Setting the temperature

1. To set the temperature, use the **temp** arrow keys to select a temperature between -11 °C and 40 °C.
2. Set the run time and *g*-force (rcf) or speed (rpm). Press the **start/stop** key to start the centrifugation.
The temperature can be changed during centrifugation.

5.10.2 Temperature display

Temperature display if the rotor stops:	Set temperature
Temperature display during centrifugation:	Actual temperature

When the *Display > Extended display* setting is activated, the display shows the target values for centrifugation time, temperature and centrifugation speed in the target value row.

5.10.3 Temperature monitoring

After the set temperature has been reached, the centrifuge reacts to temperature deviations during centrifugation as follows:

- Deviation from the set temperature $> \pm 3$ °C:
Temperature display flashes.
- Deviation from the set temperature $> \pm 5$ °C:
The display shows *ERROR 18*. Centrifugation is stopped automatically.



During temperature control, a hissing noise may occur. This noise does not impair the function of the centrifuge.

5.10.4 Temperature control run FastTemp

Prerequisites

- The centrifuge is switched on.
- Rotor and rotor lid are correctly mounted.
- The centrifuge lid is closed.
- The temperature and *g*-force (rcf) or speed (rpm) have been set for the upcoming centrifugation.

With the FastTemp function, you can immediately start a temperature run without samples, at rotor-specific or temperature-specific speeds. This will quickly bring the rotor chamber, including rotor and adapter, up to the set target temperature.

1. Set the temperature with the **temp** arrow keys.
2. Press the **fast temp** key.

The display shows the following information:

- *FastTemp*
 - Duration of the temperature control run
 - Actual temperature in the rotor chamber
 - The optimum speed (rpm) calculated for the temperature control run or the *g*-force (rcf).
3. The temperature control run FastTemp automatically ends when the target temperature has been reached.
The signal sounds 5 times.

Press the **start/stop** key to end the temperature control run early.



- The centrifuge only stops the run once the rotor has reached the set temperature. Therefore, there may be a delay between the display of the achieved target temperature and the automatic end of the temperature control run.
- The target temperature can be changed during the temperature control run, using the **temp** arrow keys. Duration and speed are adjusted automatically.



FastTemp with aerosol-tight buckets

A temperature control run with aerosol-tight buckets takes longer and may lead to a vacuum in the bucket. To achieve better cooling of the bucket and the adapter, centrifugation can be carried out without cap during a FastTemp run.

- ▶ Do not seal aerosol-tight buckets during a FastTemp run.
- ▶ If the caps cannot be undone due to a vacuum, do not pull on the sealing clamps or hooks to loosen the cap. Adjust the temperature of the buckets to ambient temperature so that the caps can be removed easily.

5.10.5 FastTemp pro: automatic temperature control run with programmed start time

Prerequisites

- The centrifuge switches on and/or is in the standby mode at the set time.
- The rotor and rotor lid are properly attached.
- The centrifuge lid is closed.

You can set the FastTemp temperature control run to start automatically at a set time. Two options are available:

- *FastTemp pro* > *One time use*: The temperature control run starts once at the set time.
- *FastTemp pro* > *Repeated use*: The temperature control run starts at the set time on the set weekday and repeats indefinitely on each additional weekday that was set.

The selection between *One time use* and *Repeated use* only appears when the FastTemp pro function has not been activated yet. If this is not the case, you can edit or delete the programmed start time.

Programming a single temperature control run

1. Press the **menu/enter** key. Use the menu arrow keys to select *Cooling System* > *FastTemp pro*.
2. Use the menu arrow keys to select *One time use*. Confirm with the **menu/enter** key.
3. Set the date, time and temperature with the menu arrow keys. Confirm with the **menu/enter** key.
The display shows an overview of the current settings.
4. Use the menu arrow keys to select *Save*. Confirm with the **menu/enter** key.

Programming repeated temperature control runs

1. Press the **menu/enter** key. Use the menu arrow keys to select *Cooling System* > *FastTemp pro*.
2. Use the menu arrow keys to select *Repeated use*. Confirm with the **menu/enter** key.
3. Activate or deactivate the weekdays with **menu/enter**. Select *Next* and confirm with **menu/enter**.
4. Set the date, time and temperature with the menu arrow keys. Confirm with the **menu/enter** key.
The display shows an overview of the current settings.
5. Use the menu arrow keys to select *Save*. Confirm with the **menu/enter** key.
 - When FastTemp pro is activated, the **FTPro** symbol appears on the display while an automatic start of a temperature control run is still outstanding.
 - The temperature control run starts automatically at the selected time.
 - After a one-off programmed temperature control run, the following symbol is extinguished **FTPro**. If there are several programmed temperature control runs, the FastTemp pro function remains active indefinitely.



If the centrifuge is running at the programmed time, the temperature control run cannot be started automatically.

Deactivating FastTemp pro

1. Press the **menu/enter** key. Use the menu arrow keys to select *Cooling System > FastTemp pro*.
2. Use the menu arrow keys to select *Delete*. Confirm with the **menu/enter** key.

5.10.6 Continuous cooling

Prerequisites

- The centrifuge is switched on.
- The centrifuge lid is closed.
- The set temperature is lower than the ambient temperature.

Continuous cooling maintains the rotor chamber at the set temperature if the rotor stops.

- During continuous cooling the display shows the set temperature.
- To prevent the rotor chamber from freezing or condensation from forming, the temperature does not go below 4 °C, irrespective of the set temperature.
- If the rotor stops, temperature control is slower than during centrifugation or a temperature control run.

ECO shut-off

ECO shut-off: Continuous cooling is switched off if the centrifuge is not used for longer than the preset time. The centrifuge switches to standby mode.

- Default setting: Continuous cooling ends after 8 h.
- Continuous cooling can be limited to 1 h, 2 h or 4 h.
- ECO shut-off can be switched off (continuous cooling set to endless operation).

Limit continuous cooling to 1 h (2 h, 4 h, 8 h)

1. Press the **menu/enter** key. Use the menu arrow keys to select *Cooling System > Continuous cooling*. Confirm with the **menu/enter** key.
2. Use the menu arrow keys to select *Eco shut-off*. Confirm with the **menu/enter** key.
3. Select *1 h, 2 h, 4 h or 8 h*. Confirm with the **menu/enter** key.
Continuous cooling ends after the preset time. The centrifuge switches to standby mode.

5.10.7 Endless operation of continuous cooling

The ECO shut-off function can be switched off. Continuous cooling is changed to endless operation.

- Endless operation can shorten the service life of the compressor.
- The rotor chamber may freeze.

1. Press the **menu/enter** key. Use the menu arrow keys to select *Cooling System > Continuous cooling*. Confirm with the **menu/enter** key.
2. Use the menu arrow keys to select ∞ . Confirm with the **menu/enter** key.

Ending continuous cooling

3. Open the centrifuge lid to end continuous cooling.

5.11 Switching off the centrifuge

1. Open the centrifuge lid.
Residual moisture can evaporate. Pressure is taken off the gas springs.
2. Remove rotor lids from fixed-angle rotors and aerosol-tight caps from buckets.
Aerosol-tight accessories may not be stored when they are connected.
3. Switch off the centrifuge using the mains/power switch.

6 Device settings

6.1 Standby mode


The centrifuge automatically switches from the ready state to the standby mode if the following prerequisites are met:


- The centrifuge is not used during the defined time period.
- The centrifuge lid is open.

Standby mode

- The LED next to the **Standby**  key lights up red.

Ready state

- The centrifugation parameters are displayed.
- The LED next to the **Standby**  key lights up green.


You can switch between the standby mode and ready state at any time when centrifugation is not performed by pressing the **Standby**  key.

6.1.1 Switching on the standby mode

1. Press the **menu/enter** key. Use the menu arrow keys to select *Settings > Standby*.
2. Use the menu arrow keys to select *OnOff* or *Set time*. Confirm with the **menu/enter** key.
If *Standby > Set time* is selected, the time period can be selected after which the centrifuge is to switch to standby mode (1 min to 60 min).

6.2 Key lock

When the key lock has been enabled, the centrifugation time, the temperature, the *g*-force (rcf) and/or RPM, the acceleration ramp/braking ramp and the status of the At set rpm function cannot be changed accidentally.

1. To enable the key lock, press the **menu/enter** key. Use the menu arrow keys to select *Key lock*. Confirm with the **menu/enter** key.
2. Use the menu arrow keys to select *On*. Confirm with the **menu/enter** key.
A tick appears in front of the selected setting. The setting takes effect immediately.
3. To exit the menu, press the left menu arrow key  several times.

6.3 Display

Standard display	When the centrifuge stands still, the set values are displayed and during centrifuging the actual values of the centrifugation parameters are displayed.
Extended display	The set value row is shown on the lower edge of the display.

6.3.1 Showing the set value row

1. Press the **menu/enter** key. Use the menu arrow keys to select *Settings > Display*. Confirm with the **menu/enter** key.
2. Use the menu arrow keys to select *Extended display*. Confirm with the **menu/enter** key.
A tick appears in front of the selected setting. The setting takes effect immediately.
3. To exit the menu, press the left menu arrow key ◀ several times.

6.3.2 Setting the contrast

1. Press the **menu/enter** key. Use the menu arrow keys to select *Settings > Contrast*. Confirm with the **menu/enter** key.
2. Change parameters with the menu arrow keys ◀ or ▶.
3. Select *Save*. Confirm with the **menu/enter** key.

6.4 Speaker

6.4.1 Switching the loudspeaker on/off

1. Press the **menu/enter** key. Use the menu arrow keys to select *Settings > Alarm*. Confirm with the **menu/enter** key.
2. Use the menu arrow keys to select *On* or *Off*. Confirm with the **menu/enter** key.
A tick appears in front of the selected setting. The setting takes effect immediately.
3. To exit the menu, press the left menu arrow key ◀ several times.

6.4.2 Setting the volume

1. Press the **menu/enter** key. Use the menu arrow keys to select *Settings > Volume*. Confirm with the **menu/enter** key.
2. Change parameters with the menu arrow keys ◀ or ▶.
3. Select *Save*. Confirm with the **menu/enter** key.

6.5 Calling up device information

- ▶ Press the **menu/enter** key. Use the menu arrow keys to select *Information > Device Information*. Confirm with the **menu/enter** key.
Device name, serial number and firmware version are displayed.

6.6 Cycle counter

Each centrifugation run in which the rotor is accelerated and braked is counted as a cycle, independent of the speed and the duration of the centrifugation run.

The usual service life of a rotor is 7 years or a maximum of 100000 cycles (see p. 66). If you expect a rotor to exceed the maximum number of cycles before the end of the 7 years, use the cycle counter as an aid.

The centrifuge detects the rotor type, but not each individual rotor. The displayed number of cycles does not give reliable information on the actual service life of a rotor.

Using the cycle counter is recommendable under the following conditions:

- Only one rotor of a rotor type is used in the centrifuge. There are no rotors of the same type in one centrifuge.
- The rotor is only used in one centrifuge. It is not used in parallel in different centrifuges.

6.6.1 Notes on reaching the maximum number of cycles



CAUTION! Danger due to material fatigue.

If the service life is exceeded, it cannot be guaranteed that the material of the rotors and the accessories will withstand the stresses during centrifugation.

- ▶ Do not use any accessories whose maximum service life has been exceeded.

Before the maximum number of cycles of a rotor is reached, a pop-up window will appear that the rotor must be exchanged.

At the following 3 times, a pop-up window will appear that the maximum number of cycles has been reached:

- 2000 cycles before reaching the maximum number of cycles
- 1000 cycles before reaching the maximum number of cycles
- 400 cycles before reaching the maximum number of cycles



- ▶ Confirm with the **menu/enter** key.
- ▶ Press the **start/stop** key to start the centrifugation.

If the maximum number of cycles has been reached, a warning will appear before each run.



- ▶ Confirm with the **menu/enter** key.
- ▶ Replace the rotor.

6.6.2 Resetting the number of cycles

After a rotor has reached the maximum number of cycles and has been replaced, the number of cycles must be reset for the rotor type.

1. Press the **menu/enter** key. Use the menu arrow keys to select *Information > Number of Cycles*. Confirm with the **menu/enter** key.

The display shows the rotor type, the cycles run and the maximum cycles.



2. Select a rotor with the arrow keys ▲ or ▼. Confirm with the **menu/enter** key.
3. Select *Reset* with the menu arrow keys ◀ or ▶. Confirm with the **menu/enter** key.

The display shows:
Reset cycles?
yes/no

4. Select *yes*. Confirm with the **menu/enter** key.
The number of cycles for the rotor type will be reset to 1.

6.6.3 Changing the number of cycles

The function *Number of Cycles > Change* is intended for the authorized service only.

7 Programs

7.1 Saving the program

The Centrifuge 5910 R has more than 99 programmable memory locations.

For each program, you can define the parameters centrifugation time, temperature and speed as well as separate settings for radius, acceleration ramps/braking ramps and the start of time counting (At set rpm function). With the timer function, you can delay the start time by up to 60 min, for instance, to bridge an incubation period.

Option	Value
<i>Radius [cm]</i>	Radius in [cm] The centrifuge must have detected the rotor.
<i>Accel. ramp</i>	0 to 9
<i>Braking ramp</i>	0 to 9
<i>At set rpm</i>	Off On
<i>Timer [min]</i>	1 min to 60 min

7.1.1 Creating a program

Prerequisites

- The centrifuge has detected the rotor.
- Rotor stop.

1. Press the **menu/enter** key. Use the menu arrow keys to select *Programs > Save program*. Confirm with the **menu/enter** key.
2. Set the centrifugation time with the **time** arrow keys.
3. Set the temperature with the **temp** arrow keys.
4. Set the speed (rpm) or the *g*-force (rcf) with the **speed** arrow keys.



Defining additional options of the program

5. Select *Options* using the right menu arrow key ►. Confirm with the **menu/enter** key.
6. Select an option, for instance, *Accel. ramp*, with the menu arrow keys ◀ or ▶.
7. Change parameters with the menu arrow keys ◀ or ▶. Confirm with the **menu/enter** key.

Saving the program

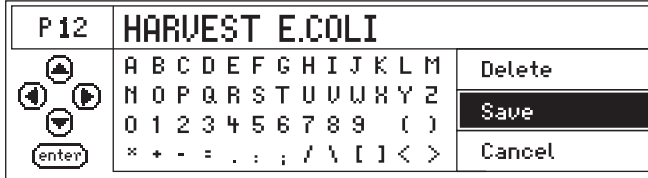
8. Use the menu arrow keys to select an empty program space.
9. Use the menu arrow keys to select *Save*. Confirm with the **menu/enter** key.
 - The program is saved in the program space (without a program name).
 - The display shows the message *Assign a program name?*

Programs

Centrifuge 5910 R
English (EN)

Allocating a program name

10. Confirm with *yes*.



11. Select letters or numbers with the menu arrow keys and confirm with the **menu/enter** key.

The program name can have a maximum of 15 characters.

To delete individual characters, select *Delete* and press the **menu/enter** key.

12. Use the menu arrow keys to select *Save*. Confirm with the **menu/enter** key.

The display shows the program with all settings.



If the message *Assign a program name?* is discarded with *no*, a name is generated from the program number, e.g. *Prog. 12*.

7.1.2 Quick save with program keys

To save the current settings quickly, you can use the program keys.

- ▶ Keep one of the program keys **prog 1** to **prog 5** pressed for 2 seconds.
 - A signal tone sounds.
 - The LED above the program key lights blue.
 - The parameters of the program are saved.



prog 1 to **prog 5** cover the program spaces 1 to 5. The programs are saved without a program name.

7.2 Loading a saved program

7.2.1 Loading program prog 1 to prog 5

1. In order to call up a program on the program spaces 1 to 5, press one of the program keys **prog 1** to **prog 5**.

- The LED above the program key lights blue.
- The display shows the parameters of the program.

2. Start the program: press the **start/stop** key.

7.2.2 Loading a program from the program list

Prerequisites

- The rotor which is suitable for the program is inserted.
 - The centrifuge has detected the rotor.
1. Press the **menu/enter** key. Select *Programs > Load program*. Confirm with the **menu/enter** key.
 2. Use the menu arrow keys ◀ or ▶ to select the program space. Confirm with the **menu/enter** key.
The display shows the parameters of the program.
 3. Start the program: press the **start/stop** key.

7.2.2.1 Error messages

If a run is started although the rotor is not compatible with the parameters of a program, notes on the possible causes will appear:

Speed is flashing in the display



g-force/speed is flashing in the display: *g*-force/speed of the selected program exceeds the maximum *g*-force/speed of the rotor.

- ▶ Correct the value for *g*-force/speed.

If the run is started without correcting the *g*-force/speed, the following message will appear:

rpm/rcf too high!

[START] Centrifugation at ### rpm/### rcf

◀ ▶ *Change parameters.*

- The message shows the maximum permitted *g*-force/speed of the rotor.
 - The rotor is not stopped, but it is held at a speed of 700 rpm.
 - You have 15 seconds to adopt the *g*-force/speed or to change it.
- ▶ Adopt the displayed *g*-force/speed for the run: press the **start/stop** key.
 - ▶ Change the *g*-force or speed for the run: use the arrow keys **speed** to set a different value.
If you do not adopt or change the *g*-force/speed within 15 s, the centrifuge will stop running.

Radius is flashing in the display



Radius is flashing in the display: The radius of the selected program is larger than the maximum radius of the rotor.

- ▶ Correct the value for radius.

If the run is started without correcting the radius, the following message will appear:

Hint D

Radius not permissible.

Change rotor.

7.2.3 Editing programs

1. Load the program with the program keys: *Menu > Programs > Load program*. Confirm with the **menu/enter** key.
2. Select a program with the menu arrow keys ◀ or ▶. Confirm with the **menu/enter** key.
The display shows the parameters of the program.
3. Press the **menu/enter** key. Use the menu arrow keys to select *Programs > Save program*. Confirm with the **menu/enter** key.
The next available program space is suggested.
4. Change parameters and options (see *Creating a program on p. 47*).
5. Select *Save*. Confirm with the **menu/enter** key.
The display shows the message *Keep program name?*
6. To change the program name, discard the message with *no* and change the program name.

7.3 Deleting a program

Programs 1 to 5 cannot be deleted. All parameters of these programs can be modified and overwritten.

1. To delete a program from program spaces 6 to 99: press the **menu/enter** key. Select *Programs > Delete program*. Confirm with the **menu/enter** key
2. Use the menu arrow keys ◀ or ▶ to select the program space. Confirm with the **menu/enter** key.
The display shows the message *Delete program?*
3. Select *yes*. Confirm with the **menu/enter** key.

8 Maintenance

8.1 Maintenance



WARNING! Risk of injury due to defective gas spring(s).

A defective gas spring is an insufficient support for the centrifuge lid. There is a risk of crushing fingers or limbs.

- ▶ Make sure that the centrifuge lid can be opened completely and that it will remain in this position.
- ▶ Regularly check all gas springs for their proper function.
- ▶ Have defective gas springs replaced immediately.
- ▶ Have gas springs replaced by a service technician every 2 years.

We recommend that the centrifuge with the associated rotors be checked at the latest every 12 months by Technical Service during maintenance. Observe the relevant national regulations.

8.2 Preparing cleaning/disinfection

- ▶ Clean all accessible surfaces of the device and the accessories at least weekly and when contaminated.
- ▶ Clean the rotor regularly. This way the rotor is protected and the durability is prolonged.
- ▶ Furthermore, observe the notes on decontamination (see *Decontamination before shipment on p. 56*) when the device is sent to the authorized Technical Service for repairs.

The procedure described in the following chapter applies to the cleaning as well as to the disinfection or decontamination. The table below describes the steps required on top of this:

Cleaning	Disinfecting/decontamination
<ol style="list-style-type: none"> 1. Use a mild cleaning fluid to clean the accessible surfaces of the device and the accessories. 2. Carry out the cleaning as described in the following chapter. 	<ol style="list-style-type: none"> 1. Choose the disinfection method which corresponds to the legal regulations and guidelines in place for your range of application. For example, use alcohol (ethanol, isopropanol) or alcohol-based disinfectants. 2. Carry out the disinfection or decontamination as described in the following chapter. 3. Then clean the device and the accessories.



If you have any further questions regarding the cleaning and disinfection or decontamination or regarding the cleaning fluid to be used, contact the Eppendorf AG Application Support. The contact details are provided on the back of this manual.

8.3 Cleaning/disinfection



DANGER! Electric shock as a result of penetration of liquid.

- ▶ Switch off the device and disconnect the power plug before starting cleaning or disinfection work.
- ▶ Do not allow any liquids to penetrate the inside of the housing.
- ▶ Do not spray clean/spray disinfect the housing.
- ▶ Only plug the device back in if it is completely dry, both inside and outside.



NOTICE! Damage from the use of aggressive chemicals.

- ▶ Do not use any aggressive chemicals on the device or its accessories, such as strong and weak bases, strong acids, acetone, formaldehyde, halogenated hydrocarbons or phenol.
- ▶ If the device has been contaminated by aggressive chemicals, immediately clean it by means of a mild cleaning agent.



NOTICE! Corrosion due to aggressive cleaning agents and disinfectants.

- ▶ Do not use corrosive cleaning agents, aggressive solvents or abrasive polishes.
- ▶ Do not incubate the accessories in aggressive cleaning agents or disinfectants for a longer period of time.



NOTICE! Damage from UV and other high-energy radiation.

- ▶ Do not use UV, beta, gamma, or any other high-energy radiation for disinfecting.
- ▶ Avoid storage in areas with strong UV radiation.



Autoclaving

Fixed-angle rotors, rotor lids, adapters, and buckets can be autoclaved (121 °C, 20 min).

Rotor crosses of swing-bucket rotors cannot be autoclaved.

After a maximum of 50 autoclaving cycles, the aerosol-tight caps and, for QuickLock rotors, the seals must be replaced.

8.3.1 Cleaning and disinfecting the device

Recommended cleaning agents:

- Alcohol 70 % (ethanol, isopropanol)
- Mild neutral cleaning agent

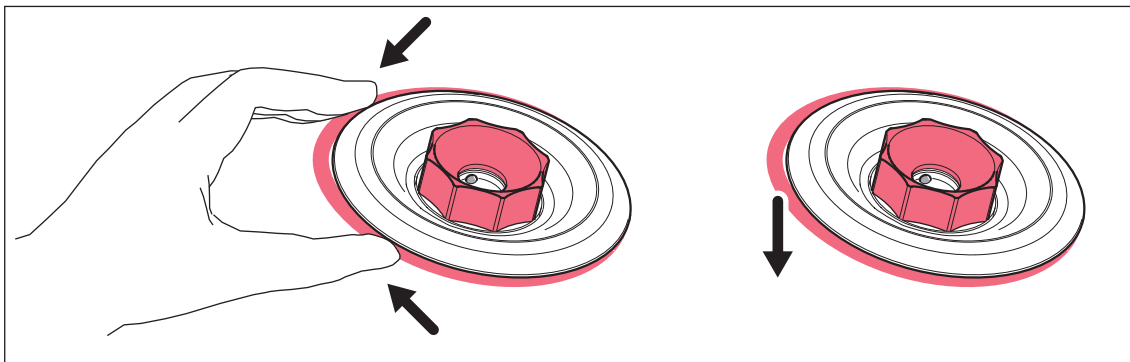
1. Open the lid. Switch the device off at the mains/power switch. Disconnect the mains/power plug from the voltage supply.
2. Remove the rotor.
3. Clean and disinfect all accessible surfaces of the device, including the power cable, using a damp cloth and the recommended cleaning agents.
4. Thoroughly clean the rubber seal of the rotor chamber with water.

5. Rub the dry rubber seal with glycerine or talcum powder to prevent it from becoming brittle. Other components of the device, such as the motor shaft and rotor cone, must not be lubricated.
6. Clean the motor shaft with a soft, dry and lint-free cloth. Do not lubricate the motor shaft.
7. Check the motor shaft for damage.
8. Check the device for corrosion and damage.
9. Leave the centrifuge lid open when the device is not being used.
10. Only connect the device to the power supply if it is fully dry inside and out.

8.3.2 Disinfecting and cleaning the rotor

1. Inspect the rotor and accessories for damage and corrosion. Do not use any damaged rotors or accessories.
2. Clean and disinfect the rotors and accessories with the recommended cleaning agents.
3. Use a bottle brush to clean and disinfect the rotor bores.
4. Clean and disinfect the rotor lid.

QuickLock rotor lids: Remove the sealing ring. Clean the sealing ring and the groove below it.



5. Rinse the rotors and accessories thoroughly with distilled water. Rinse the rotor bores of fixed-angle rotors particularly thoroughly.



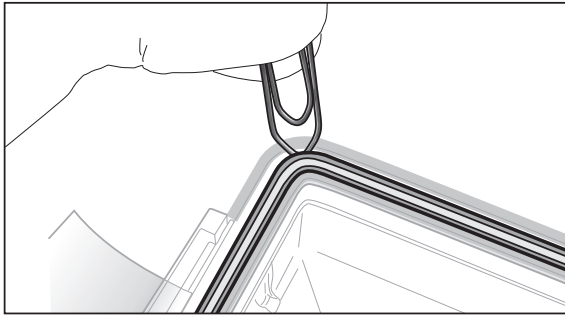
Do not immerse the rotor in liquid as liquid can get trapped inside the cavities.

6. Place the rotors and accessories on a towel to dry. Place the fixed-angle rotors with the rotor bores facing down so the bores can dry.
7. Coat the sealing ring of the rotor lid with a thin layer of pivot grease and Correctly reinsert it in the clean and dry groove.
8. Clean the rotor cone with a soft, dry and lint-free cloth. Do not lubricate the rotor cone.
9. Inspect the rotor cone for damage.
10. Place the dry rotor onto the motor shaft.
11. Tighten the rotor nut firmly by turning it **clockwise** with the rotor key.
12. Leave the rotor lid open when the rotor is not being used.

8.3.3 Changing the seal of the aerosol-tight cap (S-4xUniversal, S-4x750, S-4x400)

To clean the aerosol-tight cap, remove the seal of the aerosol-tight cap.

8.3.3.1 Removing the seal



1. Use a blunt lever to lift the seal out of the groove (e.g., use the round side of a paper clip). Make sure not to damage the seal with the wire ends.
2. Carefully lift the seal out of the groove.

8.3.3.2 Inserting the seal



NOTICE! Faulty sealing when the seal is handled incorrectly.

- ▶ Uniformly insert the seal.
- ▶ Do not pull the seal lengthwise.

1. Check that the seal is not damaged.
Do not use any damaged, discolored or dirty seals.
2. Place the seal on the groove and slightly press it into the groove.
3. Place the cap on the bucket and close it completely.
4. Remove the cap and check the correct positioning of the seal.



If the seal is too long or too short, remove the seal from the groove. Insert the seal again.

8.4 Additional care instructions for refrigerated centrifuges

- ▶ Regularly free the rotor chamber from ice formations by thawing, by either leaving the centrifuge lid open or by performing a short temperature control run at approx. 30 °C.
- ▶ To take pressure off the gas spring(s), leave the centrifuge lid open if the centrifuge is not used for a longer period.
Residual moisture can escape.
- ▶ Wipe up the condensation water in the rotor chamber. Use a soft, absorbent cloth for this.
- ▶ No later than every 6 months, remove any dust deposits from the ventilation slits of the centrifuge using a brush or swab. First switch off the device and remove the power plug.

8.5 Cleaning glass breakage

When using glass tubes there is a risk of glass breakage in the rotor chamber. The resulting glass splinters are swirled around in the rotor chamber during centrifugation and have a sandblasting effect on the rotor and accessories. The smallest glass particles become lodged in the rubber parts (e.g., the motor guide, the rotor chamber seal, and the rubber mats of adapters).



NOTICE! Glass breakage in the rotor chamber

Glass tubes in the rotor chamber may break if the *g*-force is too high. Broken glass can damage the rotor, accessories and samples.

- ▶ Please note the manufacturer's information on the recommended centrifugation parameters (load and speed).

Effects of glass breakage in the rotor chamber:

- Fine black metal abrasion in the rotor chamber (in metal rotor chambers)
- The surfaces of the rotor chamber and accessories are scratched.
- The chemical resistance of the rotor chamber is reduced.
- Contamination of samples
- Wear on rubber parts

How to proceed in case of glass breakage

1. Remove all splinters and glass powder from the rotor chamber and accessories.
2. Thoroughly clean the rotor and rotor chamber. Thoroughly clean the bores of the fixed-angle rotors, in particular.
3. If required, replace the rubber mats and adapters to prevent any further damage.
4. Regularly check the rotor bores for deposits and damage.

8.6 Resetting the excess current switch

Thermal excess current switches are mounted as fuses. If the excess current protection is triggered, they set the switch to OFF. However, they do not automatically switch it on again.

To switch on the excess current switch again, proceed as follows:

1. Switch off the centrifuge using the mains/power switch.
2. Wait for at least 20 s and switch on the centrifuge again.

The excess current switch is reactivated and the centrifuge is ready for operation.

8.7 Decontamination before shipment

If you are shipping the device to the authorized Technical Service for repairs or to your authorized dealer for disposal please note the following:



WARNING! Risk to health from contaminated device.

1. Observe the information on the decontamination certificate. You can find it as a PDF document on our webpage (www.eppendorf.com/decontamination).
 2. Decontaminate all the parts you would like to dispatch.
 3. Include the fully completed decontamination certificate in the package.
-

9 Troubleshooting

If you cannot remedy an error with the recommended measures, please contact your local Eppendorf partner. The contact addresses can be found on the Internet at www.eppendorf.com.

9.1 General errors

Problem	Cause	Solution
No display.	No mains/power connection.	▶ Check the mains/power connection.
	Mains/power outage.	▶ Check the fuse of the device. ▶ Check the mains/power fuse of the laboratory.
The centrifuge lid cannot be opened.	Rotor is still running.	▶ Wait for rotor to stop.
	Mains/power outage.	1. Disconnect the mains/power plug. 2. Let the thermal fuse in the mains/power switch cool off for at least 15 min. 3. Check the mains/power fuse of the laboratory. 4. Actuate emergency release.
The centrifuge cannot be started.	Centrifuge lid is not closed.	▶ Closing the centrifuge lid.
Centrifuge shakes when it starts up.	Rotor is asymmetrically loaded.	1. Stop the centrifuge and load the rotor symmetrically. 2. Re-start the centrifuge.
Centrifuge brakes during short spin centrifugation even though the short key is pressed.	The short key was released briefly more than twice (protective function for the drive).	▶ Press and hold the short key during a short spin centrifugation.
Temperature display flashes.	Temperature deviation from set value: $> \pm 3 \text{ }^\circ\text{C}$.	▶ Check the settings. ▶ Wait until the set temperature has been reached. ▶ Check unhindered air circulation through the air slots. ▶ Thaw ice or switch off device and allow it to cool down.

9.2 Error messages

If an error message appears, proceed as follows:

1. Remedy the fault as described in the "Remedy" column.
2. To clear the error message from the display, press the **open** key.
3. If necessary, repeat centrifugation.

Problem	Cause	Solution
<i>Hint A</i> <i>Lid latch</i>	Centrifuge lid will not lock.	▶ Try again to close centrifuge lid.
<i>Hint B</i> <i>Imbalance</i>	Rotor is asymmetrically loaded.	▶ Load the rotor symmetrically and balance it. ▶ Swing-bucket rotor: Apply a thin layer of pivot grease to the pegs.
<i>Hint C</i> <i>Rotor detection</i>	Speed (rpm) or <i>g</i> -force (rcf) is higher than the maximum speed (rpm) or the <i>g</i> -force (rcf) of the rotor.	1. Correct rpm/rcf. 2. Repeat the run.
<i>Hint D</i> <i>Rotor detection</i>	<ul style="list-style-type: none"> • The radius of the selected program is larger than the maximum radius of the rotor. • The rotor is not compatible with the program. 	▶ Change the radius. ▶ Replace the rotor.

Problem	Cause	Solution
<i>ERROR 1</i> <i>Rotor detection</i>	Rotor not detected.	▶ Check rotor. ▶ If this error message appears again, test the rotor detection with a different rotor.
<i>ERROR 2</i> <i>Electronics fault</i>	Electronics fault.	1. Switch off centrifuge and wait for 20 s. 2. Switch on centrifuge.
<i>ERROR 3</i> <i>Speed check</i>	Error in the rotational speed measurement system.	▶ Insert and tighten rotor. ▶ Wait for displayed time to elapse. ▶ Let the centrifuge stand while switched on until the error message disappears.
<i>ERROR 5</i> <i>Electronics fault</i>	Prohibited opening of lid during a run or lid switch is defective.	1. Wait for rotor to stop. 2. Open and close again the lid of the device. 3. Repeat the run.

Problem	Cause	Solution
<i>ERROR 6</i> <i>Drive fault</i>	<ul style="list-style-type: none"> • Error in the drive electronics. • Drive is overheated. 	<p>▶ Repeat the run.</p> <p>If the error message appears again:</p> <ol style="list-style-type: none"> 1. Switch off centrifuge and wait for 20 s. 2. Switch on centrifuge. <p>If the error message appears again:</p> <p>▶ Let the drive cool down for at least 15 min.</p>
	<ul style="list-style-type: none"> • Emergency release was actuated during a run. 	<p>▶ Wait for rotor to stop.</p>
<i>ERROR 7</i> <i>Speed check</i>	Deviation in the speed control.	<ol style="list-style-type: none"> 1. Wait for rotor to stop. 2. Tighten the rotor.
<i>ERROR 9 – ERROR 14</i>	Electronics fault.	<ol style="list-style-type: none"> 1. Switch off centrifuge and wait for 20 s. 2. Switch on centrifuge.
<i>ERROR 16 – ERROR 17</i> <i>Electronics fault</i>	Electronics fault.	<ol style="list-style-type: none"> 1. Switch off centrifuge and wait for 20 s. 2. Switch on centrifuge.
<i>ERROR 18, ERROR 20</i> <i>Room Temp. of rotor chamber</i>	Deviation from target temperature in the rotor chamber.	<p>▶ Allow the device to cool down and repeat cycle.</p>
<i>ERROR 22</i> <i>Electronics fault</i>	Electronics fault.	<ol style="list-style-type: none"> 1. Switch off centrifuge and wait for 20 s. 2. Switch on centrifuge.
<i>ERROR 25</i> <i>Power failure</i>	Mains/power failure during a run.	<p>▶ Check the power supply.</p>
<i>ERROR 26 – ERROR 27</i> <i>Electronics fault</i>	Electronics fault.	<ol style="list-style-type: none"> 1. Switch off centrifuge and wait for 20 s. 2. Switch on centrifuge.
<i>ERROR 28</i> <i>Electronics fault</i>	Electronics fault.	<p>▶ Press the open key.</p>
<i>ERROR 30</i> <i>Lid latch</i>	Centrifuge lid will not lock.	<p>▶ Try again to close centrifuge lid.</p>
	Centrifuge lid cannot be released.	<p>▶ Switch the device off and back on.</p> <p>If the error occurs again:</p> <ol style="list-style-type: none"> 1. Switch off the device. 2. Activate the emergency lid release.
	Centrifuge lid has not been opened wide enough.	<p>▶ Open the centrifuge lid wider by hand.</p>

9.3 Emergency release

If the centrifuge lid cannot be opened, you can activate the emergency release manually.



WARNING! Risk of injury from rotating rotor.

If the emergency release of the lid is operated, the rotor may continue rotating for several minutes.

- ▶ Wait until the rotor stop before operating the emergency release.
 - ▶ Check the monitoring glass in the centrifuge lid.
-

Use the rotor key delivered with the Centrifuge 5910 R for the emergency release. Carry out the following steps on both the left side and right side of the centrifuge.

1. Pull out the mains/power plug and wait for the rotor to stop.
2. Insert the rotor key into the hexagonal opening on one side of the centrifuge until noticeable resistance can be felt.
3. Slightly press and turn the rotor key **counterclockwise**.
4. Insert the rotor key into the hexagonal opening on the opposite side of the centrifuge until noticeable resistance can be felt.
5. Slightly press and turn the rotor key **counterclockwise**.
This will release the centrifuge lid.
6. Open the centrifuge lid.

10 Transport, storage and disposal

10.1 Transport

- ▶ Remove the rotor from the centrifuge before transport.
- ▶ Use the original packing for transport.

	Air temperature	Relative humidity	Atmospheric pressure
General transport	-25 °C – 60 °C	10 % – 75 %	30 kPa – 106 kPa
Air freight	-20 °C – 55 °C	10 % – 75 %	30 kPa – 106 kPa

10.2 Storage

	Air temperature	Relative humidity	Atmospheric pressure
In transport packing	-25 °C – 55 °C	10 % – 75 %	70 kPa – 106 kPa
Without transport packing	-5 °C – 45 °C	10 % – 75 %	70 kPa – 106 kPa

10.3 Disposal

In case the product is to be disposed of, the relevant legal regulations are to be observed.

Information on the disposal of electrical and electronic devices in the European Community:

Within the European Community, the disposal of electrical devices is regulated by national regulations based on EU Directive 2012/19/EU pertaining to waste electrical and electronic equipment (WEEE).

According to these regulations, any devices supplied after August 13, 2005, in the business-to-business sphere, to which this product is assigned, may no longer be disposed of in municipal or domestic waste. To document this, they have been marked with the following identification:



Because disposal regulations may differ from one country to another within the EU, please contact your supplier if necessary.

Transport, storage and disposal

Centrifuge 5910 R

English (EN)

11 Technical data

11.1 Power supply

Centrifuge 5910 R

Mains/power connection	230 V \pm 10 %, 50 Hz – 60 Hz 120 V \pm 10 %, 50 Hz – 60 Hz 100 V \pm 10 %, 50 Hz – 60 Hz
Current consumption	10.5 A (230 V) 12 A (120 V) 15 A (100 V)
Power consumption	maximum 1 650 W (230 V) maximum 1 440 W (120 V) maximum 1 500 W (100 V)
EMC: Noise emission (radio interference)	230 V: EN 61326-1/EN55011 – Class A 120 V: CFR 47 FCC Part 15 – Class A 100 V: EN 61326-1/EN55011 – Class A
EMC: Noise immunity	EN 61326
Overvoltage category	II
Degree of pollution	2

11.2 Weight/dimensions

Dimensions	Width: 71.5 cm (28.1 in) Depth: 62.0 cm (24.4 in)/66 cm (26.0 in) Height: 36.8 cm (14.5 in)
Weight without rotor	109.0 kg (240.3 lb)

11.3 Noise level

The noise level was measured frontally in a sound measuring chamber with accuracy class 1 (DIN EN ISO 3745) at a distance of 1 m from the device and at lab bench height.

	Swing-bucket rotor	Fixed-angle rotor
Noise level at maximum rotor speed	< 53 dB(A) (S-4xUniversal) < 54 dB(A) (S-4x750)	< 58 dB(A) (FA-6x50)

11.4 Ambient conditions

Environment	For indoor use only.
Ambient temperature	10 °C – 35 °C
Relative humidity	10 % – 75 %, non-condensing.
Atmospheric pressure	79.5 kPa – 106 kPa Use up to a height of 2 000 m above sea level.

11.5 Application parameters

Cycle time	10 s – 99:59 h, infinite (∞), <ul style="list-style-type: none"> • 10 s – 2 min: can be set in increments of 10 s • 2 min – 10 min: can be set in increments of 30 s • 10 min – 99:59 h: can be set in increments of 1 min
Temperature	-11 °C – 40 °C
Relative centrifugal force	$1 \times g$ – $22132 \times g$ <ul style="list-style-type: none"> • $1 \times g$ – $3000 \times g$: can be set in increments of $10 \times g$ • $3000 \times g$ – $22132 \times g$: can be set in increments of $100 \times g$
Speed	10 rpm – 14000 rpm <ul style="list-style-type: none"> • 10 rpm – 5000 rpm: can be set in increments of 10 rpm • 5000 rpm – 14000 rpm: can be set in increments of 100 rpm
Maximum load	Fixed-angle rotor: 6 × 50 mL Swing-bucket rotors: 4 × 750 mL
Maximum kinetic energy	36400 J
Permissible density of the material for centrifuging (at maximum g -force (rcf) or speed (rpm) and maximum load)	1.2 g/mL
Inspection obligation in Germany	yes

11.6 Acceleration and deceleration times

The following table shows the approximate acceleration and deceleration times according to DIN 58970 for the rotors of the Centrifuge 5910 R. The data was determined at maximum load of the rotor. Fluctuations may occur depending on the condition of the device and the load.

- Level 9: shortest acceleration time/deceleration time
- Level 0: longest acceleration time/deceleration time (brake off)

Rotor		0	1	2	3	4	5	6	7	8	9
S-4xUniversal (5910 R – 230 V, 120 V)	Acceleration time	506 s	294 s	208 s	144 s	108 s	86 s	80 s	73 s	68 s	64 s
	Deceleration time	1609 s	706 s	264 s	182 s	122 s	92 s	75 s	63 s	57 s	49 s
	Tolerance	–	–	±5 %*							
S-4xUniversal (5910 R – 100 V)	Acceleration time	912 s	485 s	329 s	224 s	158 s	119 s	105 s	89 s	79 s	70 s
	Deceleration time	1674 s	542 s	269 s	181 s	124 s	90 s	75 s	63 s	55 s	46 s
	Tolerance	–	–	±5 %*							
S-4x750	Acceleration time	406 s	257 s	184 s	123 s	91 s	71 s	57 s	49 s	43 s	36 s
	Deceleration time	1017 s	383 s	235 s	157 s	106 s	82 s	69 s	54 s	44 s	35 s
	Tolerance	–	–	±5 %*							
S-4x500	Acceleration time	345 s	218 s	157 s	104 s	77 s	60 s	48 s	41 s	35 s	28 s
	Deceleration time	771 s	360 s	200 s	131 s	95 s	71 s	53 s	44 s	39 s	30 s
	Tolerance	–	–	±5 %*							
S-4x400	Acceleration time	406 s	260 s	180 s	120 s	86 s	63 s	54 s	43 s	38 s	30 s
	Deceleration time	860 s	386 s	220 s	156 s	108 s	77 s	65 s	52 s	45 s	35 s
	Tolerance	–	–	±5 %*							
FA-6x50	Acceleration time	351 s	239 s	167 s	115 s	85 s	63 s	55 s	46 s	40 s	34 s
	Deceleration time	686 s	330 s	215 s	154 s	107 s	77 s	62 s	49 s	41 s	31 s
	Tolerance	–	–	±5 %*							
FA-20x5	Acceleration time	304 s	205 s	140 s	95 s	70 s	51 s	44 s	36 s	32 s	26 s
	Deceleration time	605 s	290 s	190 s	133 s	93 s	69 s	56 s	44 s	39 s	28 s
	Tolerance	–	–	±5 %*							
FA-48x2	Acceleration time	251 s	169 s	117 s	80 s	58 s	44 s	37 s	30 s	28 s	22 s
	Deceleration time	546 s	235 s	151 s	107 s	77 s	55 s	46 s	37 s	32 s	24 s
	Tolerance	–	–	±5 %*							
FA-30x2	Acceleration time	245 s	164 s	114 s	77 s	57 s	44 s	37 s	31 s	26 s	21 s
	Deceleration time	359 s	224 s	147 s	103 s	74 s	51 s	43 s	35 s	29 s	23 s
	Tolerance	–	–	±5 %*							
F-48x15	Acceleration time	205 s	137 s	95 s	63 s	45 s	34 s	29 s	24 s	21 s	18 s
	Deceleration time	397 s	196 s	117 s	82 s	56 s	40 s	34 s	28 s	23 s	18 s
	Tolerance	–	–	±5 %*							

* 5 s minimum

11.7 Service life for accessories



CAUTION! Danger due to material fatigue.

If the service life is exceeded, it cannot be guaranteed that the material of the rotors and the accessories will withstand the stresses during centrifugation.

- ▶ Do not use any accessories whose maximum service life has been exceeded.

Eppendorf states the maximum service life of the rotors and accessories both in years and in the maximum number of cycles. The decisive factor for the service life is which case occurs first, usually this is the number of years in operation.

Each centrifugation run in which the rotor is accelerated and braked is counted as a cycle, independent of the speed and the duration of the centrifugation run.

Rotor	Maximum service life after initial setup	
S-4xUniversal	50000 cycles	7 years
S-4x750	100000 cycles	7 years
S-4x500	100000 cycles	7 years
S-4x400	100000 cycles	7 years
FA-6x50	100000 cycles	7 years
FA-20x5	100000 cycles	7 years
FA-48x2	100000 cycles	7 years
FA-30x2	100000 cycles	7 years
F-48x15	100000 cycles	7 years

All other rotors and rotor lids can be used during the entire service life of the centrifuge if the following conditions are met:

- Proper use
- Recommended maintenance
- Undamaged condition

Accessories	Maximum service life after initial setup	
Rotor lid of polycarbonate (PC), polypropylene (PP) or polyetherimide (PEI)	–	3 years
QuickLock rotor lid		3 years
Seals in the QuickLock rotor lid	50 autoclaving cycles	–
Caps of polycarbonate (PC), polypropylene (PP) or polyetherimide (PEI)	50 autoclaving cycles	3 years
Adapters	–	1 year

The date of manufacture is stamped on the rotors and buckets in the format *03/15* or *03/2015* (= March 2015). On the inside of the plastic-rotor lids and aerosol-tight caps, the date of manufacture is stamped in the form of a clock ⌚.

Measures to ensure aerosol tightness:

- ▶ Replace the seal of QuickLock rotor lids after 50 autoclaving cycles.
- ▶ Replace aerosol-tight caps after 50 autoclaving cycles.

12 Rotors for the Centrifuge 5910 R




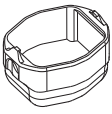

Eppendorf centrifuges may only be operated with rotors that are intended for use with the corresponding centrifuge.


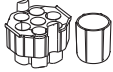

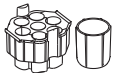
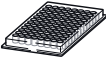
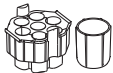

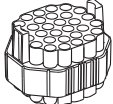
- ▶ Only use rotors that are intended for use with the corresponding centrifuge.

Please note the manufacturer's information on the centrifugation stability of the sample tubes used (maximum *g*-force).

12.1 Rotor S-4xUniversal


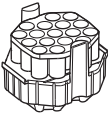
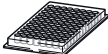
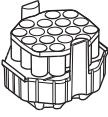
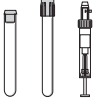
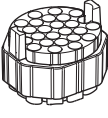

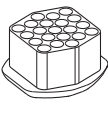

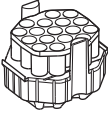
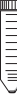
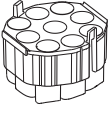

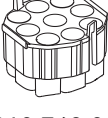
12.1.1 Swing-bucket rotor S-4xUniversal with 4 Universal Buckets


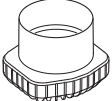

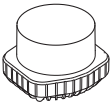
			Max. <i>g</i> -force: 4347 × <i>g</i>
			Max. speed: 4500 rpm
Rotor S-4xUniversal	Universal Bucket and aerosol-tight cap	Max. load per bucket (adapter, tube and contents): 1595 g	

Tube	Tube Capacity Number per adapter/ rotor	Adapter Order no. (international)	Bottom shape Diameter Max. tube length with/without cap	Max. <i>g</i> -force Max. speed Radius
	Conical tube 50 mL 7/28	 5910 751.001	Conical Ø 29 mm 121 mm/124 mm	4324 × <i>g</i> 4500 rpm 19.1 cm
	Wide-neck bottle 250 mL 1/4	 5910 751.001	Flat Ø 62 mm 139 mm/146 mm	4234 × <i>g</i> 4500 rpm 18.7 cm
	Microplate 96/384 wells 1/4	 5910 751.001	Flat –/16 mm	2604 × <i>g</i> 4500 rpm 11.5 cm
	Round-bottom tube 4 mL – 8 mL (Ø 13 × 75 mm – 100 mm) 30/120	 5910 755.007	Round Ø 13 mm 117 mm/119 mm	4302 × <i>g</i> 4500 rpm 19.0 cm

Rotors for the Centrifuge 5910 R


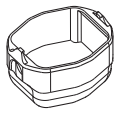

Centrifuge 5910 R
English (EN)

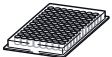

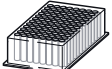

Tube	Tube Capacity Number per adapter/ rotor	Adapter Order no. (international)	Bottom shape Diameter Max. tube length with/without cap	Max. <i>g</i> -force Max. speed Radius
	Eppendorf Tubes 5 mL 16/64	 5910 752.008 (without upper part)	Conical Ø 17 mm 122 mm/124 mm	4324 × <i>g</i> 4500 rpm 19.1 cm
	Microplate 96/384 wells 1/4	 5910 752.008 (without upper part)	Flat -64 mm	3237 × <i>g</i> 4500 rpm 14.3 cm
	Round-bottom tube 7.5 mL – 12 mL (Ø 16 × 75 mm – 100 mm) 26/104	 5910 754.000	Round Ø 16 mm 118 mm/120 mm	4302 × <i>g</i> 4500 rpm 19.0 cm
	Tube 9 mL (Ø 17.5 mm × 100 mm) 21/84	 5910 762.003	Round Ø 17.5 mm 118 mm/120 mm	4256 × <i>g</i> 4500 rpm 18.8 cm
	Conical tube 15 mL 16/64	 5910 752.008	Conical Ø 17 mm 122 mm/124 mm	4324 × <i>g</i> 4500 rpm 19.1 cm
	Conical tube 50 mL 9/36	 5910 769.008	Conical Ø 29 mm -116 mm	4347 × <i>g</i> 4500 rpm 19.2 cm
	Microplate 96/384 wells 1/4	 5910 769.008	Flat -16 mm	2604 × <i>g</i> 4500 rpm 11.5 cm

Tube	Tube Capacity Number per adapter/ rotor	Adapter Order no. (international)	Bottom shape Diameter Max. tube length with/without cap	Max. <i>g</i> -force Max. speed Radius
	Conical tube 500 mL Corning 1/4	 5910 760.000	Conical Ø 96 mm -/148 mm	4234 × <i>g</i> 4500 rpm 18.7 cm
	Wide-neck bottle 750 mL 1/4	 5910 757.000	Flat Ø 102 mm 135 mm/139 mm	4256 × <i>g</i> 4500 rpm 18.8 cm

12.1.2 Swing-bucket rotor S-4xUniversal with 4 Universal Buckets and plate carrier

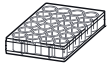

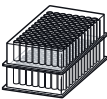


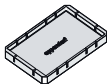
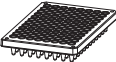
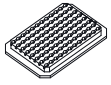
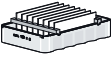

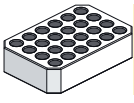

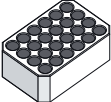
For centrifugation of the following plate and vessels always use the plate carrier. Use plate carrier and adapter if necessary.

			Max. <i>g</i> -force: 3849 × <i>g</i> Max. speed: 4500 rpm
Rotor S-4xUniversal	Universal Bucket with plate carrier		Max. load per bucket (adapter, tube and contents): 1 595 g

Plate/tube	Plate Capacity Number per adapter/ rotor	Adapter Order no. (international)	Bottom shape Max. loading height	Max. <i>g</i> -force Max. speed Radius
	Microplate 96/384 wells 5/20	 5910 753.004	Flat 66 mm/80 mm	3849 × <i>g</i> 4500 rpm 17.0 cm
	Deepwell plate 96 wells 1/4	 5910 753.004	Flat 66 mm/80 mm	3849 × <i>g</i> 4500 rpm 17.0 cm

Rotors for the Centrifuge 5910 R

Centrifuge 5910 R
English (EN)

Plate/tube	Plate Capacity Number per adapter/rotor	Adapter Order no. (international)	Bottom shape Max. loading height	Max. <i>g</i> -force Max. speed Radius
	Cell-culture plate 1/4	 5910 753.004	Flat 66 mm/80 mm	$3849 \times g$ 4500 rpm 17.0 cm
	Kit 1/4	 5910 753.004	Flat -/80 mm	$3849 \times g$ 4500 rpm 17.0 cm
	PCR plate 384 wells 1/4	Plate carrier +  5825 713.001	Flat 66 mm/80 mm	$3645 \times g$ 4500 rpm 16.1 cm
	PCR plate 96 wells 1/4	Plate carrier +  5825 711.009	Conical 66 mm/80 mm	$3690 \times g$ 4500 rpm 16.3 cm
Slide	CombiSlide 12 slides 12/48	Plate carrier +  5825 706.005	Flat 66 mm/80 mm	$3758 \times g$ 4500 rpm 16.6 cm
	IsoRack 24 × 0.5 mL micro test tubes 1/4	Plate carrier +  5825 708.008	Open Ø 6 mm 66 mm/80 mm	$3690 \times g$ 4500 rpm 16.3 cm
	IsoRack 24 × 1.5/2 mL micro test tubes 1/4	Plate carrier +  5825 709.004	Open Ø 11 mm 66 mm/80 mm	$3600 \times g$ 4500 rpm 15.9 cm

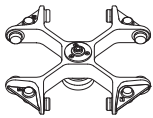


12.2 Rotor S-4x750


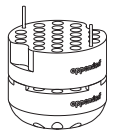



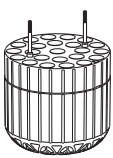
12.2.1 Swing-bucket rotor S-4x750 with 4 750 mL round buckets

Impact of rotational speed on temperature with the 120 V device model

To maintain a temperature of 4 °C with an ambient temperature of 23 °C, rotational speed must be reduced to 4400 rpm.

Rotational speed	Temperature
4400 rpm	4 °C
4700 rpm	6 °C


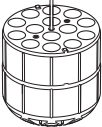



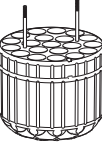





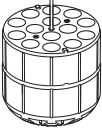
			Max. <i>g</i> -force:	100 V: 4031 × <i>g</i>	120 V/230 V: 4816 × <i>g</i>
			Max. speed:	100 V: 4300 rpm	120 V/230 V: 4700 rpm
Rotor S-4x750	Round bucket 750 mL	Aerosol-tight cap	Max. load per bucket (adapter, tube and contents):	1000 g	1000 g




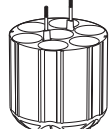








Tube	Tube Capacity Tubes per adapter/rotor	Adapter Order no. (international)	Bottom shape Diameter Max. tube length with/ without cap	Max. <i>g</i> -force Max. speed Radius	
				100 V	120 V/230 V
	Micro test tube 1.5 mL/2 mL 50/200	 5825 740.009	Open Ø 11 mm 39 mm	Top: 3059 × <i>g</i> Bottom: 4010 × <i>g</i> 4300 rpm Top: 14.8 cm Bottom: 19.4 cm	Top: 3655 × <i>g</i> Bottom: 4791 × <i>g</i> 4700 rpm Top: 14.8 cm Bottom: 19.4 cm
	Round-bottom tube Ø 12 mm × 75 mm 27/108	 5825 747.003	Round Ø 12 mm 113 mm/120 mm	3845 × <i>g</i> 4300 rpm 18.6 cm	4594 × <i>g</i> 4700 rpm 18.6 cm
	Round-bottom tube 4 mL – 8 mL (Ø 13 mm × 75 mm – 100 mm) 23/92	 5825 738.004	Round Ø 13 mm 113 mm/121 mm	3824 × <i>g</i> 4300 rpm 18.5 cm	4569 × <i>g</i> 4700 rpm 18.5 cm

Rotors for the Centrifuge 5910 R

Centrifuge 5910 R

English (EN)

Tube	Tube Capacity Tubes per adapter/rotor	Adapter Order no. (international)	Bottom shape Diameter Max. tube length with/ without cap	Max. g-force Max. speed Radius	
				100 V	120 V/230 V
	Eppendorf Tubes 5 mL 14/56	 5825 734.009 (without upper part)	Conical Ø 17 mm 65 mm	3886 × g 4300 rpm 18.8 cm	4643 × g 4700 rpm 18.8 cm
	Round-bottom tube 7.5 mL – 12 mL (Ø 16 mm × 75 mm – 100 mm) 20/80	 5825 736.001	Round Ø 16 mm 120 mm/125 mm	3845 × g 4300 rpm 18.6 cm	4594 × g 4700 rpm 18.6 cm
	Round-bottom tube 8 mL – 16 mL 7/28 (Load inner bores only (see p. 31))	 5825 736.001	Round Ø 16 mm (Do not use the aerosol-tight cap.)/ 125 mm	3845 × g 4300 rpm 18.6 cm	4594 × g 4700 rpm 18.6 cm
	Tube 9 mL (Ø 17.5 mm × 100 mm) 20/80	 5825 743.008	Round Ø 17.5 mm 112 mm/117 mm	3824 × g 4300 rpm 18.5 cm	4569 × g 4700 rpm 18.5 cm
	Round-bottom tube 14 mL 14/56	 5825 748.000	Round Ø 17.5 mm 106 mm	3824 × g 4300 rpm 18.5 cm	4569 × g 4700 rpm 18.5 cm
	Conical tube 15 mL 14/56	 5825 734.009	Conical Ø 17 mm × 104 mm 120 mm/125 mm	3886 × g 4300 rpm 18.8 cm	4643 × g 4700 rpm 18.8 cm

Tube	Tube Capacity Tubes per adapter/rotor	Adapter Order no. (international)	Bottom shape Diameter Max. tube length with/ without cap	Max. g-force Max. speed Radius	
				100 V	120 V/230 V
	Conical tube (skirted) 30 mL	 5825 755.006	Conical Ø 25 mm 114 mm/119 mm	3742 × g 4300 rpm 18.1 cm	4470 × g 4700 rpm 18.1 cm
	Conical tube 50 mL 7/28	 5825 733.002	Conical Ø 29 mm 116 mm/122 mm	3866 × g 4300 rpm 18.7 cm	4618 × g 4700 rpm 18.7 cm
	Conical tube (skirted) 50 mL 5/20	 5825 732.006	Conical Ø 29 mm 116 mm/122 mm	3659 × g 4300 rpm 17.7 cm	4371 × g 4700 rpm 17.7 cm
	Wide-neck bottle/conical tube 175 mL – 250 mL 1/4	 5825 741.005	Flat Ø 62 mm 125 mm/145 mm	3786 × g 4300 rpm 18.3 cm	4519 × g 4700 rpm 18.3 cm
	Conical tube 500 mL Corning 1/4	 5825 745.000	Conical Ø 96 mm (Do not use the aerosol-tight cap.)/ 147 mm	3845 × g 4300 rpm 18.6 cm	4594 × g 4700 rpm 18.6 cm
	Wide-neck bottle 750 mL 1/4	 5825 744.004	Flat Ø 102 mm 150 mm/150 mm	3824 × g 4300 rpm 18.5 cm	4569 × g 4700 rpm 18.5 cm

Rotors for the Centrifuge 5910 R

Centrifuge 5910 R
English (EN)

12.2.2 Swing-bucket rotor S-4x750 with 4 plate buckets

For centrifugation of the following plate and vessels always use the plate carrier. Use plate carrier and adapter if necessary.

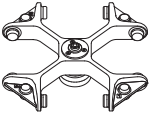

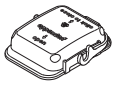
			Max. <i>g-force</i> : 3976 × <i>g</i>
			Max. speed: 4700 rpm
Rotor S-4x750	Plate bucket (always use with a plate carrier)	Aerosol-tight cap	Max. load per bucket (adapter, plate and contents): 450 g

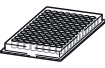

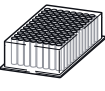

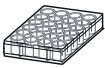

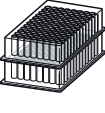


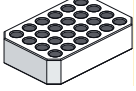

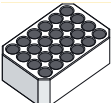
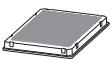
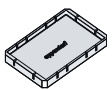
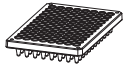
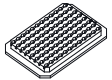

Plate	Plate Capacity Number per adapter/rotor	Adapter Order no. (international)	Bottom shape Max. loading height	Max. <i>g-force</i> Max. speed Radius
	Microplate 96/384 wells 4/16	 5820 756.004	Flat 47 mm/64 mm	3976 × <i>g</i> 4700 rpm 16.1 cm
	Deepwell plate 96 wells 1/4	 5820 756.004	Flat 47 mm/64 mm	3976 × <i>g</i> 4700 rpm 16.1 cm
	Cell-culture plate 2/8	 5820 756.004	Flat 47 mm/64 mm	3976 × <i>g</i> 4700 rpm 16.1 cm
	Kit 1/4	 5820 756.004	Flat 47 mm/64 mm	3976 × <i>g</i> 4700 rpm 16.1 cm
	IsoRack 24 × 0.5 mL micro test tubes 1/4	Plate carrier +  5825 708.008	Open Ø 6 mm 47 mm/64 mm	3803 × <i>g</i> 4700 rpm 15.4 cm

Plate	Plate Capacity Number per adapter/rotor	Adapter Order no. (international)	Bottom shape Max. loading height	Max. <i>g</i> -force Max. speed Radius
	IsoRack 24 × 1.5/2 mL micro test tubes 1/4	Plate carrier +  5825 709.004	Open Ø 11 mm 47 mm/64 mm	3704 × <i>g</i> 4700 rpm 15.0 cm
	PCR plate 384 wells 1/4	Plate carrier +  5825 713.001	Flat 47 mm/64 mm	3754 × <i>g</i> 4700 rpm 15.2 cm
	PCR plate 96 wells 1/2	Plate carrier +  5825 711.009	Conical 47 mm/64 mm	3803 × <i>g</i> 4700 rpm 15.4 cm
Slide	CombiSlide 12 slides 12/48	Plate carrier +  5825 706.005	Flat 47 mm/64 mm	3877 × <i>g</i> 4700 rpm 15.7 cm

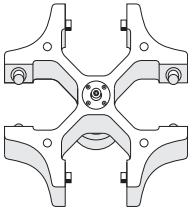

Rotors for the Centrifuge 5910 R













Centrifuge 5910 R















English (EN)

12.3 Rotor S-4x500

12.3.1 Swing-bucket rotor S-4x500 with 4 500 mL rectangular buckets

			Max. <i>g</i> -force: 3220 × <i>g</i>
			Max. speed: 4000 rpm
Rotor S-4x500	Rectangular bucket 500 mL	Aerosol-tight cap	Max. load per bucket (adapter, tube and contents): 780 g

Tube	Tube Capacity Tubes per adapter/ rotor	Adapter Order no. (international)	Bottom shape Diameter Max. tube length with/without cap	Max. <i>g</i> -force Max. speed Radius
	Micro test tube 1.5/2 mL 20/80	 5810 745.004	Flat Ø 11 mm 43 mm/43 mm	2950 × <i>g</i> 4000 rpm 16.5 cm
	Blood collection tube 1.2 mL – 5 mL 20/80	 5810 746.000	Flat Ø 11 mm 108 mm/108 mm	3000 × <i>g</i> 4000 rpm 16.8 cm
	Tube 2.6 mL – 5 mL 25/100	 5810 720.001	Flat Ø 13 mm 107 mm/108 mm	3000 × <i>g</i> 4000 rpm 16.8 cm
	Tube 2.6 mL – 7 mL 18/72	 5810 747.007	Flat Ø 13 mm 108 mm/108 mm	3000 × <i>g</i> 4000 rpm 16.8 cm
	Blood collection tube 3 mL – 15 mL 16/64	 5810 748.003	Flat Ø 16 mm 108 mm/108 mm	3000 × <i>g</i> 4000 rpm 16.8 cm
	Tube 7 mL – 17 mL 16/64	 5810 721.008	Flat Ø 17.5 mm 118 mm/118 mm	3000 × <i>g</i> 4000 rpm 16.8 cm

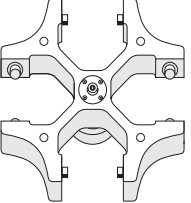
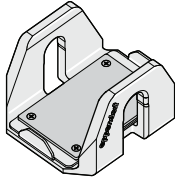
Tube	Tube Capacity Tubes per adapter/ rotor	Adapter Order no. (international)	Bottom shape Diameter Max. tube length with/without cap	Max. <i>g</i> -force Max. speed Radius
	Conical tube 15 mL 12/48	 5810 722.004	Conical Ø 17.5 mm 119 mm/121 mm	3100 × <i>g</i> 4000 rpm 17.3 cm
	Conical tube 50 mL 5/20	 5810 723.000	Conical Ø 31 mm 116 mm/122 mm	3100 × <i>g</i> 4000 rpm 17.3 cm
	Centriprep 50 mL 5/20	 5810 739.004	Flat Ø 31 mm -/121 mm	3100 × <i>g</i> 4000 rpm 17.3 cm
	Conical tube, skirted 50 mL 5/20	 5810 739.004  5804 737.008	Flat Ø 31 mm -/119 mm	3100 × <i>g</i> 4000 rpm 17.3 cm
	Bottles 180 mL – 250 mL 1/4	 5825 722.000	Flat Ø 62 mm -/133 mm	3100 × <i>g</i> 4000 rpm 17.3 cm
	Wide-neck bottle 400 mL 1/4	 5810 728.002	Flat Ø 81 mm -/133 mm	3220 × <i>g</i> 4000 rpm 18.0 cm
	Wide-neck bottle, rectangular 500 mL -/4	–	Flat 83 mm 134 mm/134 mm	3220 × <i>g</i> 4000 rpm 18.0 cm

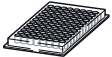
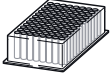
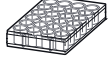


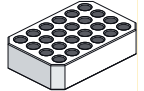

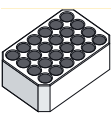

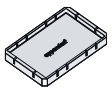
Rotors for the Centrifuge 5910 R

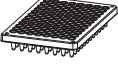
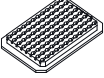
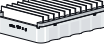
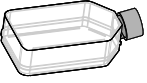
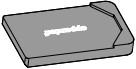
Centrifuge 5910 R

English (EN)

12.3.2 Swing-bucket rotor S-4x500 with 4 MTP/Flex buckets

		Max. <i>g</i> -force:	2900 × <i>g</i>
		Max. speed:	4000 rpm
Rotor S-4x500	MTP/Flex buckets	Max. load per bucket (adapter, tube and contents):	380 g

Tube	Plate Capacity Number per adapter/rotor	Adapter Order no. (international)	Bottom shape Diameter Max. loading height	Max. <i>g</i> -force Max. speed Radius
	Microplate 96/384 wells 4/16	–	Flat – 60 mm	2900 × <i>g</i> 4000 rpm 16.3 cm
	Deepwell plate 96 wells 1/4	–	Flat – 60 mm	2900 × <i>g</i> 4000 rpm 16.3 cm
	Cell-culture plate 2/8	–	Flat – 60 mm	2900 × <i>g</i> 4000 rpm 16.3 cm
	Kit 1/4	–	Flat – 60 mm	2900 × <i>g</i> 4000 rpm 16.3 cm
	IsoRack 24 × 0.5 mL micro test tubes 1/4	 5825 708.008	Flat Ø 6 mm 60 mm	2700 × <i>g</i> 4000 rpm 15.0 cm
	IsoRack 24 × 1.5/2 mL micro test tubes 1/4	 5825 709.004	Flat Ø 11 mm 60 mm	2600 × <i>g</i> 4000 rpm 14.6 cm
	PCR plate 384 wells 1/4	 5825 713.001	Flat – 60 mm	2700 × <i>g</i> 4000 rpm 15.8 cm

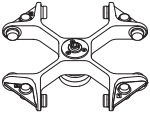


Tube	Plate Capacity Number per adapter/rotor	Adapter Order no. (international)	Bottom shape Diameter Max. loading height	Max. <i>g</i> -force Max. speed Radius
	PCR plate 96 wells 1/4	 5825 711.009	Flat – 60 mm	2 600 × <i>g</i> 4 000 rpm 16.1 cm
Slide	CombiSlide 12 slides 12/48	 5825 706.005	Flat – 60 mm	1,000 × <i>g</i> 2 372 rpm 15.9 cm
	Cell culture bottle with/without filter 25 cm ² : Sarstedt 83.1810.002/ 83.1810 Greiner Bio-One 690175/690160 TPP 90026/90025 IWAKI 3102-025 1/4	 5825 719.000	Flat – 60 mm	1,000 × <i>g</i> 2 501 rpm 14.3 cm


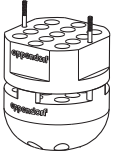



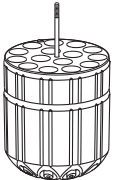

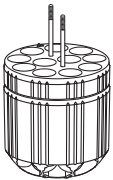
Rotors for the Centrifuge 5910 R

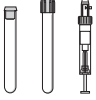
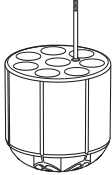

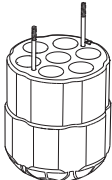

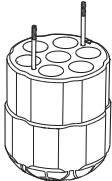

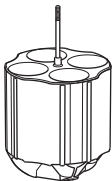


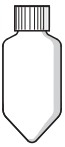

Centrifuge 5910 R

English (EN)

12.4 Rotor S-4x400

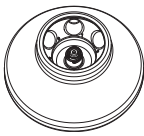
			Max. <i>g</i> -force: 5234 × <i>g</i>
			Max. speed: 5100 rpm
Rotor S-4x400	Round bucket 400 mL	Aerosol-tight cap	Max. load per bucket (adapter, tube and contents): 570 g











Tube	Tube Capacity Tubes per adapter/ rotor	Adapter Order no. (international)	Bottom shape Diameter Max. tube length with/without cap	Max. <i>g</i> -force Max. speed Radius
	Micro test tube 1.5 mL/2 mL 26/104	 5910 708.009	Open Ø 11 mm 39 mm	Top: 3897 × <i>g</i> Bottom: 5147 × <i>g</i> 5,100 rpm Top: 13.4 cm Bottom: 17.7 cm
	Round-bottom tube Ø 12 mm × 75 mm 17/68	 5910 711.000	Round Ø 12 mm 112 mm/118 mm	5002 × <i>g</i> 5100 rpm 17.2 cm
	Round-bottom tube 4 mL – 8 mL (Ø 13 mm × 75 mm – 100 mm) 15/60	 5910 703.007	Round Ø 13 mm 105 mm/119 mm	4973 × <i>g</i> 5100 rpm 17.1 cm
	Round-bottom tube 7.5 mL – 12 mL (Ø 16 mm × 75 mm – 100 mm) 11/44	 5910 704.003	Round Ø 16 mm 115 mm/122 mm	5031 × <i>g</i> 5100 rpm 17.3 cm












Tube	Tube Capacity Tubes per adapter/ rotor	Adapter Order no. (international)	Bottom shape Diameter Max. tube length with/without cap	Max. <i>g</i> -force Max. speed Radius
	Round-bottom tube 9 mL (Ø 17.5 mm × 100 mm)	 5910 709.005	Round Ø 17.5 mm 115 mm/122 mm	5 031 × <i>g</i> 5 100 rpm 17.3 cm
	Eppendorf Tubes 5 mL	 5910 702.000 (without upper part)	Conical Ø 17 mm 126 mm/133 mm	5 234 × <i>g</i> 5 100 rpm 18.0 cm
	Conical tube 15 mL	 5910 702.000	Conical Ø 17 mm 126 mm/133 mm	5 234 × <i>g</i> 5 100 rpm 18.0 cm
	Conical tube 50 mL	 5910 701.004	Conical Ø 29 mm 117 mm/125 mm	5 205 × <i>g</i> 5 100 rpm 17.9 cm
	Wide-neck bottle/ conical tube 175 mL – 250 mL 1/4	 5910 705.000	Flat For conical tubes, also use manufac- turer's adapter. Ø 62 mm 129 mm/138 mm	5 060 × <i>g</i> 5 100 rpm 17.4 cm
	Conical tube 175 mL – 225 mL 1/4	 5910 714.009	Conical Ø 62 mm 137 mm/143 mm	5 263 × <i>g</i> 5 100 rpm 18.1 cm

12.5 Rotor FA-6x50

Aerosol-tight fixed-angle rotor for 6 conical tubes

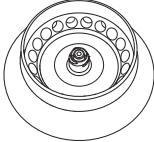
	Max. <i>g</i> -force:	20130 × <i>g</i>
	Max. speed:	12100 rpm
Rotor FA-6x50	Max. load (adapter, tube and contents):	6 × 75 g








Tube	Tube Capacity Tubes per adapter/ rotor	Adapter Order no. (international)	Bottom shape Diameter Max. tube length with rotor lid	Max. <i>g</i> -force Max. speed Radius
	Round-bottom tube 16 mL 1/6	 5820 720.000	round Ø 18.1 mm 107 mm	19642 × <i>g</i> 12100 rpm 12.0 cm
	Round-bottom tube 2.6 mL – 5 mL (Ø 13 mm × 75 mm) 1/6	 5820 726.008	round Ø 13.5 mm –	19642 × <i>g</i> 12100 rpm 12.0 cm
	Round-bottom tube 4 mL – 8 mL (Ø 13 mm × 100 mm) 1/6	 5820 725.001	round Ø 13.5 mm 119 mm	19642 × <i>g</i> 12100 rpm 12.0 cm
	Eppendorf Tubes 5 mL 1/6	 5820 730.005	conical Ø 17 mm –	19806 × <i>g</i> 12100 rpm 12.1 cm
	Round-bottom tube 5.5 mL – 10 mL (Ø 16 mm × 75 mm) 1/6	 5820 728.000	round Ø 16 mm –	19642 × <i>g</i> 12100 rpm 12.0 cm

Tube	Tube Capacity Tubes per adapter/ rotor	Adapter Order no. (international)	Bottom shape Diameter Max. tube length with rotor lid	Max. <i>g</i> -force Max. speed Radius
	Round-bottom tube 7.5 mL – 12 mL (Ø 16 mm × 100 mm) 1/6	 5820 727.004	round Ø 16.4 mm 119 mm	19642 × <i>g</i> 12100 rpm 12.0 cm
	Tube 9 mL 1/6	 5820 729.007	round Ø 16.4 mm 112 mm	19642 × <i>g</i> 12100 rpm 12.0 cm
	Conical tube 15 mL 1/6	 5820 717.009	conical Ø 17 mm 125 mm	19642 × <i>g</i> 12100 rpm 12.0 cm
	Round-bottom tube 30 mL 1/6	 5820 721.006	round Ø 25.7 mm 104 mm	17187 × <i>g</i> 12100 rpm 10.5 cm
	Conical tube 35 mL 1/6	 5820 722.002	conical Ø 28.7 mm 113 mm	18333 × <i>g</i> 12100 rpm 11.2 cm
	Conical tube 50 mL 1/6	–	conical Ø 30 mm 127 mm	20133 × <i>g</i> 12100 rpm 12.3 cm

12.6 Rotor FA-20x5

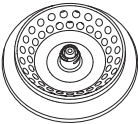
Aerosol-tight fixed-angle rotor for 20 tubes










	Max. <i>g</i> -force:	20913 × <i>g</i>
	Max. speed:	13100 rpm
Rotor FA-20x5	Max. load (adapter, tube and contents):	20 × 9.5 g

Tube	Tube Capacity Tubes per adapter/ rotor	Adapter Order no. (international)	Bottom shape Diameter	Max. <i>g</i> -force Max. speed Radius
	HPLC vessel 1/20	 5820 770.007	Ø 11 mm	17076 × <i>g</i> 13100 rpm 8.9 cm
	Cryo tube 1.0 mL/2.0 mL 1/20	 5820 769.009	Ø 13 mm	18802 × <i>g</i> 13100 rpm 9.8 cm
	Reaction tube 1.5 mL/2.0 mL 1/20	 5820 768.002	open Ø 11 mm	18227 × <i>g</i> 13100 rpm 9.5 cm
	Eppendorf Tubes 5 mL -/20		conical Ø 17 mm	20913 × <i>g</i> 13100 rpm 10.9 cm

12.7 Rotor FA-48x2

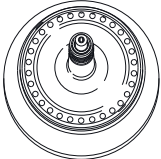
Aerosol-tight fixed-angle rotor for 48 micro test tubes










	Max. <i>g</i> -force:	
	Outer ring	22 132 × <i>g</i>
	Inner ring	19 502 × <i>g</i>
	Max. speed:	14 000 rpm
Rotor FA-48x2	Max. load (adapter, tube and contents):	48 × 3.75 g

Tube	Tube Capacity Tubes per adapter/ rotor	Adapter Order no. (international)	Bottom shape Diameter	Max. <i>g</i> -force Outer ring Inner ring Max. speed Radius Outer ring Inner ring
	PCR tube 0.2 mL 1/48	 5425 715.005	Conical Ø 6 mm	17 530 × <i>g</i> 14 901 × <i>g</i> 14 000 rpm 8 cm 6.8 cm
	Micro test tube 0.4 mL 1/48	 5425 717.008	Conical Ø 6 mm	22 132 × <i>g</i> 19 502 × <i>g</i> 14 000 rpm 10.1 cm 8.9 cm
	Micro test tube 0.5 mL 1/48	 5425 716.001	– Ø 8 mm	19 722 × <i>g</i> 17 092 × <i>g</i> 14 000 rpm 9 cm 7.8 cm
	Microtainers 0.6 mL 1/48	 5425 716.001	– Ø 8 mm	22 132 × <i>g</i> 19 502 × <i>g</i> 14 000 rpm 10.1 cm 8.9 cm
	Micro test tube 1.5 mL/2 mL –/48		Round Ø 11 mm	22 132 × <i>g</i> 19 502 × <i>g</i> 14 000 rpm 10.1 cm 8.9 cm

12.8 Rotor FA-30x2

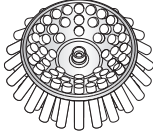
Aerosol-tight fixed-angle rotor for 30 micro test tubes







	Max. <i>g</i> -force:	20 984 × <i>g</i>
	Max. speed:	13 700 rpm
Rotor FA-30x2	Max. load (adapter, tube and contents):	30 × 3.5 g

Tube	Tube Capacity Tubes per adapter/ rotor	Adapter Order no. (international)	Bottom shape Diameter	Max. <i>g</i> -force Max. speed Radius
	Micro test tube 1.5/2 mL –/30	–	– Ø 11 mm	20 984 × <i>g</i> 13 700 rpm 10.0 cm
	PCR tube 0.2 mL 1/30	 5425 715.005	Conical Ø 6 mm	15 948 × <i>g</i> 13 700 rpm 7.6 cm
	Micro test tube 0.4 mL 1/30	 5425 717.008	Conical Ø 6 mm	20 817 × <i>g</i> 13 700 rpm 9.7 cm
	Micro test tube 0.5 mL 1/30	 5425 716.001	Open Ø 8 mm	18 400 × <i>g</i> 13 700 rpm 8.6 cm
	Microtainers 0.6 mL 1/30	 5425 716.001	Open Ø 8 mm	20 817 × <i>g</i> 13 700 rpm 9.7 cm

12.9 Rotor F-48x15

Fixed-angle rotor with 48 steel cores

	Max. <i>g</i> -force	5005 × <i>g</i>
	Max. speed	5500 rpm
Rotor F-48x15	Max. load (sleeve, adapter, tube and contents)	48 × 56 g

Tube 	Tube Capacity Tubes per adapter/ rotor	Adapter 	Bottom shape Diameter Max. tube length	Max. <i>g</i>-force Max. speed	
				Radius	
	Tube 7.5 mL to 12 mL 1/48		Flat Ø 16 mm 127 mm	5005 × <i>g</i> 5500 rpm 14.8 cm	
	Conical tube 15 mL 1/36		Conical Ø 17 mm 127 mm	5005 × <i>g</i> 5500 rpm 14.8 cm	

Rotors for the Centrifuge 5910 R

Centrifuge 5910 R

English (EN)

13 Ordering information

13.1 Rotors and accessories

The order numbers for the adapters can be found in the chapter "Rotors for Centrifuge 5910 R" (see p. 69).

13.1.1 Rotor S-4xUniversal

Order no. (International)	Order no. (North America)	Description
5895 200.001 5895 201.008	5895200001 5895201008	Rotor S-4xUniversal incl. universal buckets without universal buckets
5895 202.004 5895 203.000	5895202004 5895203000	Universal Bucket S-4xUniversal 2 pieces 4 pieces
5910 750.005	5910750005	Aerosol-tight cap Rotor S-4xUniversal, Universal Buckets 2 pieces
5910 770.006	5910770006	Seals for aerosol-tight caps Rotor S-4xUniversal, Universal Buckets 4 pieces

13.1.2 Rotor S-4x750

Order no. (International)	Order no. (North America)	Description
5895 120.008	5895120008	Rotor S-4x750 incl. round bucket
5895 123.007 5895 122.000	5895123007 5895122000	Round bucket S-4x750 2 pieces 4 pieces
5820 747.005	5820747005	Aerosol-tight cap Rotors S-4-104, S-4x750, S-4x1000, round bucket 750 mL/1000 mL 2 pieces
5820 749.008	5820749008	Seals for aerosol-tight caps Rotors S-4-104, S-4x750, S-4x1000, round bucket 750 mL/1000 mL 4 pieces

Order no. (International)	Order no. (North America)	Description
5895 128.009	5895128009	Rotor S-4x750 incl. plate bucket
5895 125.000 5895 124.003	5895125000 5895124003	Plate bucket (aerosol-tight capable) for Rotor S-4x750 2 pieces 4 pieces

Ordering informationCentrifuge 5910 R
English (EN)

Order no. (International)	Order no. (North America)	Description
5820 748.001	5820748001	Aerosol-tight cap Rotors S-4-104, S-4x750, Plate Bucket 2 pieces
5820 780.002	5820780002	Seals for aerosol-tight caps Rotors S-4-104, S-4x750, S-4x1000, Plate/Tube Bucket 4 pieces
5820 756.004	5820756004	Plate carrier Rotors A-2-DWP-AT, S-4-104, S-4x750 2 pieces

13.1.3 Rotor S-4x500

Order no. (International)	Order no. (North America)	Description
5895 170.005 5895 171.001	5895170005 5895171001	Rotor S-4x500 for 500 mL rectangular buckets or MTP/Flex-buckets incl. 4 × 500 mL rectangular buckets without bucket
5810 730.007	022638629	Rectangular bucket 500 mL Set of 4
5810 742.005 5810 741.009	022638866 022638840	MTP/Flex buckets 2 pieces 4 pieces

13.1.4 Rotor S-4x400

Order no. (International)	Order no. (North America)	Description
5895 180.000 5895 181.007	5895180000 5895181007	Rotor S-4x400 incl. round bucket 400 mL without bucket
5895 183.000 5895 182.003	5895183000 5895182003	Round bucket S-4x400 2 pieces 4 pieces
5910 700.008	5910700008	Aerosol-tight cap Rotor S-4x400, round buckets 400 mL 2 pieces
5910 710.003	5910710003	Seals for aerosol-tight caps Rotor S-4x400, round buckets 400 mL 2 pieces

13.1.5 Rotor FA-6x50

Order no. (International)	Order no. (North America)	Description
5895 150.004	5895150004	Rotor FA-6x50 aerosol-tight, 6 × 50 mL conical tubes incl. aerosol-tight rotor lid
5895 151.000	5895151000	Rotor lid FA-6x50 aerosol-tight, aluminum
5418 709.008	022652109	Seal for rotor lid FA-45-18-11 (5418/5418 R), FA-45-6-30 (5804/5804 R/5810/ 5810 R), FA-6x50 (5910 R, 5920 R) 5 pieces

13.1.6 Rotor FA-20x5

Order no. (International)	Order no. (North America)	Description
5895 130.003	5895130003	Rotor FA-20x5 aerosol-tight, 20 × 5 mL tubes incl. aerosol-tight rotor lid
5895 131.000	5895131000	Rotor lid FA-20x5 aerosol-tight, aluminum
5409 718.002	5409718002	Seal for rotor lid FA-45-20-17 (5804/5804 R/5810/5810 R), FA-20x5 (5910 R, 5920 R) 5 pieces

13.1.7 Rotor FA-48x2

Order no. (International)	Order no. (North America)	Description
5895 135.005	5895135005	Rotor FA-48x2 aerosol-tight, 48 × 1,5/2 mL tubes incl. aerosol-tight rotor lid
5895 136.001	5895136001	Rotor lid FA-48x2 aerosol-tight, aluminum
5820 767.006	5820767006	Seal for rotor lid FA-45-24-11-Kit (5427 R/530/5430 R), FA-45-48-11 (5427 R/5430/ 5430 R, 5804/5804 R/5810/5810 R), FA-30x2 (5910 R, 5920 R), FA-48x2 (5910 R, 5920 R) 5 pieces

Ordering informationCentrifuge 5910 R
English (EN)**13.1.8 Rotor FA-30x2**

Order no. (International)	Order no. (North America)	Description
5895 155.006	5895155006	Rotor FA-30x2 aerosol-tight, 30 × 1,5/2 mL tubes incl. aerosol-tight rotor lid
5895 156.002	5895156002	Rotor lid FA-30x2 aerosol-tight, aluminum
5820 767.006	5820767006	Seal for rotor lid FA-45-24-11-Kit (5427 R/530/5430 R), FA-45-48-11 (5427 R/5430/ 5430 R, 5804/5804 R/5810/5810 R), FA-30x2 (5910 R, 5920 R), FA-48x2 (5910 R, 5920 R) 5 pieces

13.1.9 Rotor F-48x15

Order no. (International)	Order no. (North America)	Description
5895 160.000	5895160000	Rotor F-48x15 for 48 × 15 mL conical tubes incl. 48 steel sleeves and adapters
5820 774.002	5820774002	Steel sleeves and adapter for vessels 15 mL for rotors F-35-48-17 (5804/5804 R/5810/5810 R) , F-48x15 (5910 R) (5804/5804 R/5810/5810 R) , F-48x15 (5910 R)

13.2 Accessories

Order no. (International)	Order no. (North America)	Description
0113 005.106	–	Rotor key
0113 204.486	–	Mains/power cord 230 V/50 Hz, Europe
0113 204.680	–	230 V/50 Hz, GB/HK
0013 613.953	–	230 V/50 Hz, CN
0113 204.699	–	230 V/50 Hz, AUS
0113 205.105	–	230 V/50 Hz, ARG
0113 206.292	022664999	100 V/120 V, 50 Hz/60 Hz, USA, JP
5810 350.050	022634330	Pivot grease Tube 20 mL

Index

A

Acceleration ramp	38, 47, 65
Acceleration times	65
Aerosol-tight cap	32
Changing the seal	54
Aerosol-tight centrifugation	32, 34
At set rpm	38, 47

B

Brake off	38
Braking ramp	38, 47, 65

C

Centrifugation time	35
Centrifuge	
Switching off the centrifuge	42
Switching on the centrifuge	23
Centrifuge lid	
Closing the centrifuge lid	33
Gas spring	11, 42, 51
Opening the centrifuge lid	23
Cleaning	52
Close	33
Continuous run	36
Contrast	44
Cycle time	
Cycle time flashes	36
Setting the cycle time	35
Cycles	45
Changing the number of cycles	46
Maximum number of cycles	45
Resetting the number of cycles	46

D

Date	23
Deceleration times	65
Decontamination	56
Device Information	44

Disinfection	52
Display	22, 44
Contrast	44
Display during centrifugation	35
Set value row	44
Disposal	61

E

Emergency release	60
End of centrifugation	36
Ending centrifugation	36
Error message	58

G

g-force	
Setting the g-force	35
Gas spring	11, 42, 51

I

Imbalance calibration	29
Inserting the rotor	24
Installation	
Preparing installation	20
Selecting a location	19

K

Key lock	43
Keys	21

L

Language	23
Lid	
Closing the lid	33
Gas spring	11, 42, 51
Opening the lid	23
Loading buckets	30
Loading plates	30
Loading the rotor	
Fixed-angle rotor	26
Swing-bucket rotor	28

IndexCentrifuge 5910 R
English (EN)

M		
Mains/power connection	19	
Mixed equipping	32	
N		
Number of cycles	45	
O		
Open	23	
Operating controls.....	21	
P		
Program		
Creating a program	47	
Options.....	47	
Program key.....	48	
Program name.....	48	
Saving the program.....	47, 48	
Program list.....	49	
Q		
QuickLock rotor lid.....	27, 34	
Quicksaving	48	
R		
Radius.....	37, 47	
Radius is flashing.....	49	
Ramp	38, 65	
rcf		
Setting rcf.....	35	
Removing the rotor.....	24	
Rotational speed		
Setting the rotational speed	35	
Rotor		
Cleaning the rotor	53	
Resetting the number of cycles	46	
Service life exceeded	45	
Rotor cycles.....	45	
Rotor detection.....	25	
Rotor lid		
Closing the QuickLock rotor lid	27	
Closing the rotor lid	26	
Rotor replacement	24	
Message after rotor change.....	25	
rpm		
Setting rpm.....	35	
S		
Selecting a location.....	19	
Set value row	22, 44	
Short run centrifugation	37	
Short Spin	25, 37	
Speaker	44	
Speed	35	
Speed is flashing	49	
Standby.....	43	
Starting	35	
Starting centrifugation.....	35	
Stop.....	36	
Storage.....	61	
Switching off.....	42	
Switching on	23	
T		
Technical data		
Ambient conditions	64	
Temperature.....	35	
Time.....	23	
Setting the time	35	
Time flashes	36	
Time counting		
Start of time counting.....	38	
Timer.....	47	
Transporting the bucket.....	32	
U		
Unpacking.....	20	
V		
Volume.....	44	

Declaration of Conformity

The product named below fulfills the requirements of directives and standards listed. In the case of unauthorized modifications to the product or an unintended use this declaration becomes invalid. This declaration of conformity is issued under the sole responsibility of the manufacturer.

Product name:

Centrifuge 5910 R

including components

Product type:

Centrifuge

Relevant directives / standards:

2006/42/EC: EN ISO 12100

2014/35/EU: EN 61010-1, EN 61010-2-020, IEC 61010-1, IEC 61010-2-020

UL 61010-1, UL 61010-2-020

CAN/CSA C22.2 No. 61010-1, CAN/CSA C22.2 No. 61010-2-020

2014/30/EU: EN 61326-1, EN 55011

47 CFR FCC part 15

2014/68/EU: EN 378-1, EN 378-2

2011/65/EU: EN 50581

Person authorized to compile

the technical file acc. to 2006/42/EC: Dr. Reza Hashemi
Executive Director Portfolio Management Centrifugation
Eppendorf AG

Hamburg, November 20, 2017



Dr. Wilhelm Plüster
Management Board



Dr. Reza Hashemi
Portfolio Management

Your local distributor: www.eppendorf.com/contact
Eppendorf AG · Barkhausenweg 1 · 22339 Hamburg · Germany
eppendorf@eppendorf.com

Eppendorf® and the Eppendorf Brand Design are registered trademarks of Eppendorf AG, Germany.
All rights reserved, incl. graphics and pictures. Copyright ©2017 by Eppendorf AG.

www.eppendorf.com

ISO
9001
Certified

ISO
13485
Certified

ISO
14001
Certified

5942 900.327-00

CERTIFICATE OF COMPLIANCE

Certificate Number 2017-08-21-E215059
Report Reference E215059-D1002-1/A0/C0-ULCB
Issue Date 2017-08-21
Issued to: EPPENDORF A G
Applicant Company: BARKHAUSENWEG 1
22339 HAMBURG GERMANY
Listed Company: Same as Applicant

This is to certify that representative samples of Laboratory centrifuge
5942 (5910 R)

Have been investigated by UL in accordance with the Standard(s) indicated on this Certificate.

Standard(s) for Safety: UL 61010-1, 3rd Edition, May 11, 2012, Revised April 29 2016, CAN/CSA-C22.2 No. 61010-1-12, 3rd Edition, Revision dated April 29 2016, IEC 61010-1:2010 (Third Edition)

Additional Standards: IEC 61010-2-020:2016 (Third Edition, issue date 2016-05-01), CAN/CSA-C22.2 NO. 61010-2-020:2017 (Third Edition, issue date 2017-01-01),

UL 61010-2-020 (Third Edition, issue date 2016-12-15).

Additional Information: See the UL Online Certifications Directory at www.ul.com/database for additional information.

Only those products bearing the UL Certification Mark should be considered as being covered by UL's Certification and Follow-Up Service.

Look for the UL Certification Mark on the product.

This is to certify that representative samples of the product as specified on this certificate were tested according to the current UL requirements.

Bruce Mahrenholz *Joseph Hoseney*

Bruce Mahrenholz, Assistant Chief Engineer, Global Inspection and Field Services, UL LLC
Joseph Hoseney, General Manager, Director of Sales – Canada, UNDERWRITERS LABORATORIES OF CANADA INC.

Helena Y. Wolf

Helena Y. Wolf, Director, Global Market Access Operations, UL LLC

Any information and documentation involving UL Mark services are provided on behalf of UL LLC (UL) or any authorized licensee of UL. For questions, please contact a local UL Customer Service Representative www.ul.com/contactus





Certificate of Containment Testing

Containment Testing of Caps (5820 741.309-00) for Rotor S- 4x750 with Roundbuckets (5895 102.115-00) in the Eppendorf 5920/R Bench Top Centrifuge

Report No. 14/014

Report Prepared For: Eppendorf AG, Hamburg, Germany

Issue Date: 26th June 2014

Test Summary

Caps (5820 741.309-00) for rotor S-4x750 with Roundbuckets (5895 102.115-00) were containment tested in the Eppendorf 5920/R bench top centrifuge, using Annex AA of IEC 61010-2-020:2006 (2nd Ed.). The sealed rotor was shown to contain a spill within the centrifuge.

Report Written By

Name: Mr Matthew Hewitt

Title: Biosafety Scientist

Report Authorised By

Name: Mrs Sara Speight

Title: Senior Biosafety Scientist



Public Health
England

Public Health England
Microbiology Services
Porton Down
Salisbury
Wiltshire
SP4 OJG

Certificate of Containment Testing

Containment Testing of Rotor S-4x750 (5895 120.105-00) with Plate Buckets (5895 124.119-00*) and Caps (5895 104.304-00[#]) in an Eppendorf Bench Top Centrifuge

Report No. 14/043 B

Report Prepared For: Eppendorf AG, Hamburg, Germany

Issue Date: 17th February 2015

Test Summary

Rotor S-4x750 (5895 120.105-00) with Plate Buckets (5895 124.119-00*) and Caps (5895 104.304-00[#]) was containment tested in an Eppendorf bench top centrifuge, using Annex AA of IEC 61010-2-020:2006 (2nd Ed.). The sealed buckets were shown to contain a spill.

Report Written By

Name: Ms Anna Moy

Title: Biosafety Scientist

Report Authorised By

Name: Mrs Sara Speight

Title: Senior Biosafety Scientist

Please be aware that the use of the Royal Coat of Arms is highly restricted and cannot be copied. Please do not put the PHE logo on your website or use our name to endorse your products. Any reference to PHE needs to be approved by us before it can be used.

* Part no. will form part of catalogue number 5895 128.009; 5895 124.003; 5895 125.000

Part no. will form part of catalogue number 5895 111.009



Public Health
England

Public Health England
Microbiology Services
Porton Down
Salisbury
Wiltshire
SP4 OJG

Certificate of Containment Testing

Containment Testing of Rotor S-4x750 (5895 120.105-00) with Plate Buckets (5895 124.119-00*) and Caps (5820 743.301-00[#]) in an Eppendorf Bench Top Centrifuge

Report No. 14/043 A

Report Prepared For: Eppendorf AG, Hamburg, Germany

Issue Date: 17th February 2015

Test Summary

Rotor S-4x750 (5895 120.105-00) with Plate Buckets (5895 124.119-00*) and Caps (5820 743.301-00[#]) was containment tested in an Eppendorf bench top centrifuge, using Annex AA of IEC 61010-2-020:2006 (2nd Ed.). The sealed buckets were shown to contain a spill.

Report Written By

Name: Ms Anna Moy

Title: Biosafety Scientist

Report Authorised By

Name: Mrs Sara Speight

Title: Senior Biosafety Scientist

Please be aware that the use of the Royal Coat of Arms is highly restricted and cannot be copied. Please do not put the PHE logo on your website or use our name to endorse your products. Any reference to PHE needs to be approved by us before it can be used.

* Part no. will form part of catalogue number 5895 128.009; 5895 124.003; 5895 125.000

Part no. will form part of catalogue number 5820 748.001



Certificate of Containment Testing

Containment Testing of Rotor S-4x400 (5895 180.108-00) with Roundbucket (5895 182.119-00*) and Caps (5910 700.105-00[#]) in an Eppendorf Bench Top Centrifuge

Report No. 17/006 A

Report Prepared For: Eppendorf AG, Hamburg, Germany

Issue Date: 28 June 2017

Test Summary

Rotor S-4x400 (5895 180.108-00) with Roundbucket (5895 182.119-00*) and Caps (5910 700.105-00[#]) was containment tested in an Eppendorf bench top centrifuge, using Annex AA of IEC 61010-2-020:2016 (3rd Ed.). The sealed buckets were shown to contain a spill.

Report Written By

Name: Ms Anna Moy

Title: Biosafety Scientist

Report Authorised By

Name: Mrs Sara Speight

Title: Senior Biosafety Scientist

Please be aware that the use of the Royal Coat of Arms is highly restricted and cannot be copied. Please do not put the PHE logo on your website or use our name to endorse your products. Any reference to PHE needs to be approved by us before it can be used.

* Part no. will form part of catalogue number 5895 180.000; 5895 182.003; 5895 183.000

Part no. will form part of catalogue number 5910 700.008



Certificate of Containment Testing

Containment Testing of Rotor FA-6x50 (5895 150.101-00*) in an Eppendorf Bench Top Centrifuge

Report No. 14/029 A

Report Prepared For: Eppendorf AG, Hamburg, Germany

Issue Date: 17th February 2015

Test Summary

Rotor FA-6x50 (5895 150.101-00*) was containment tested in an Eppendorf bench top centrifuge, using Annex AA of IEC 61010-2-020:2006 (2nd Ed.). The sealed rotor was shown to contain a spill.

Report Written By

Name: Ms Anna Moy

Title: Biosafety Scientist

Report Authorised By

Name: Mrs Sara Speight

Title: Senior Biosafety Scientist

Please be aware that the use of the Royal Coat of Arms is highly restricted and cannot be copied. Please do not put the PHE logo on your website or use our name to endorse your products. Any reference to PHE needs to be approved by us before it can be used.



Public Health
England

Public Health England
Microbiology Services
Porton Down
Salisbury
Wiltshire
SP4 OJG

Certificate of Containment Testing

Containment Testing of Rotor FA-20x5 (5895 130.100-00*) in an Eppendorf Bench Top Centrifuge

Report No. 14/029 B

Report Prepared For: Eppendorf AG, Hamburg, Germany
Issue Date: 17th February 2015

Test Summary

Rotor FA-20x5 (5895 130.100-00*) was containment tested in an Eppendorf bench top centrifuge, using Annex AA of IEC 61010-2-020:2006 (2nd Ed.). The sealed rotor was shown to contain a spill.

Report Written By

Name: Ms Anna Moy

Title: Biosafety Scientist

Report Authorised By

Name: Mrs Sara Speight

Title: Senior Biosafety Scientist

Please be aware that the use of the Royal Coat of Arms is highly restricted and cannot be copied. Please do not put the PHE logo on your website or use our name to endorse your products. Any reference to PHE needs to be approved by us before it can be used.



Public Health
England

Public Health England
Microbiology Services
Porton Down
Salisbury
Wiltshire
SP4 OJG

Certificate of Containment Testing

Containment Testing of Rotor FA-48x2 (5895 135.102-00*) in an Eppendorf Bench Top Centrifuge

Report No. 14/029 C

Report Prepared For: Eppendorf AG, Hamburg, Germany

Issue Date: 17th February 2015

Test Summary

Rotor FA-48x2 (5895 135.102-00*) was containment tested in an Eppendorf bench top centrifuge, using Annex AA of IEC 61010-2-020:2006 (2nd Ed.). The sealed rotor was shown to contain a spill.

Report Written By

Name: Ms Anna Moy

Title: Biosafety Scientist

Report Authorised By

Name: Mrs Sara Speight

Title: Senior Biosafety Scientist

Please be aware that the use of the Royal Coat of Arms is highly restricted and cannot be copied. Please do not put the PHE logo on your website or use our name to endorse your products. Any reference to PHE needs to be approved by us before it can be used.



Certificate of Containment Testing

Containment Testing of Rotor FA-30x2 (5895 155.103-00*) in an Eppendorf Bench Top Centrifuge

Report No. 14/029 D

Report Prepared For: Eppendorf AG, Hamburg, Germany

Issue Date: 17th February 2015

Test Summary

Rotor FA-30x2 (5895 155.103-00*) was containment tested in an Eppendorf bench top centrifuge, using Annex AA of IEC 61010-2-020:2006 (2nd Ed.). The sealed rotor was shown to contain a spill.

Report Written By

Name: Ms Anna Moy

Title: Biosafety Scientist

Report Authorised By

Name: Mrs Sara Speight

Title: Senior Biosafety Scientist

Please be aware that the use of the Royal Coat of Arms is highly restricted and cannot be copied. Please do not put the PHE logo on your website or use our name to endorse your products. Any reference to PHE needs to be approved by us before it can be used.

Evaluate Your Manual

Give us your feedback.
www.eppendorf.com/manualfeedback