



**VWR Signature**  
**Single and Multi-channel Electronic Pipettors**

**Operation Manual**  
**Version: 2.9**

[www.vwr.com](http://www.vwr.com)







**VWR International**  
1310 Goshen Parkway  
West Chester, PA 19380  
USA

**Declaration of Conformity**

**Product Name:** VWR Signature Single/Multi-channel Electronic Pipettors

**Model Names:** SE10-1, SE20-1, SE200-1, SE1200-1  
SE10-8, SE20-8, SE200-8, SE1200-8

All models comply with the following European standards:

**EMC:** EN 55011, Class A  
EN 60601-1-2

To the best of my knowledge and belief, these units conform to these standards.

Name: Mike Revesz  
Position: Director of Quality Assurance

**Copyright Notice:**

No part of this manual may be reproduced or transmitted in any form or by any means, electronic or mechanical, for any purpose, without prior written permission of VWR International, Inc.

## Table of Contents

<b>1. Safety Precautions</b> .....	<b>1</b>
1.1. Operation Safety Precautions	1
1.2. Battery Safety	1
<b>2. General Description</b> .....	<b>3</b>
2.1. Features	3
2.2. Ranges and Specifications	4
<b>3. Getting Started</b> .....	<b>4</b>
3.1. Unpacking	4
3.2. Inserting the Battery	5
3.3. Charging the Battery	6
3.4. Start Pipetting	8
3.5. Manual Blow-out Operation	10
3.6. Hanger Installation	10
<b>4. VWR Signature electronic pipettor Overview</b> .....	<b>11</b>
4.1. Keypad Function	12
4.2. Audible Signals	13
<b>5. Function Map</b> .....	<b>14</b>
<b>9. SYS (System) Mode</b> .....	<b>15</b>
6.1. Aspirating Speed	15
6.2. Dispensing Speed	16
6.3. Audible Signals	16
6.4. Blow-out	16
6.5. Reverse Pipetting	17
6.6. Setting PROG (Programs)	18
<b>7. AUTO Mode</b> .....	<b>19</b>

<b>8. MD (Multiple Dispensing) Mode .....</b>	<b>21</b>
<b>9. MIX Mode....</b>	<b>22</b>
<b>10. SE (Sequential Aspirating/Dispensing) Mode .....</b>	<b>22</b>
10.1. SA (Sequential Aspirating) Mode	23
10.2. SD (Sequential Dispensing) Mode	24
<b>11. Sterilization..</b>	<b>26</b>
11.1. Removal of the Lower Piston Assembly	27
11.2. Reattach the lower piston assembly	28
<b>12. Maintenance</b>	<b>30</b>
<b>13. Troubleshooting.....</b>	<b>31</b>
<b>Appendix A: Technical Specifications .....</b>	<b>33</b>
<b>Appendix B : Tip Ejector Height Adjustment.....</b>	<b>33</b>
<b>Appendix C: Warranty.....</b>	<b>34</b>

## 1. Safety Precautions

Before using the VWR Signature electronic pipettor for the first time, please read this entire operating manual carefully. To guarantee problem free, safe operation, it is essential to observe the following points:

### 1.1. Operation Safety Precautions



When using infectious, radioactive, toxic and other solutions which may pose health risks, please observe appropriate safety precautions.

1. Do not use the VWR Signature electronic pipettor in a potentially explosive environment or with potentially explosive chemicals.
2. When using organic solvents or corrosive chemicals, please check their compatibility with the pipette tips and the VWR electronic pipettor.
3. Repair should be carried out by VWR's authorized service personnel only. Contact VWR International, Inc. for information on authorized service options.
4. Use original spare parts and accessories only.

### 1.2. Battery Safety



The VWR Signature electronic pipettors operate on a small but powerful Lithium-ion battery. Misuse or abuse of the Lithium-ion battery may cause damage or injury through fire, electric shock, or chemical leakage. Please read and understand all warnings before using the battery.

1. When storing the battery, do not allow it to come into contact with any metallic surfaces.

2. Never use the VWR Signature electronic pipettors while using the DC-in jack to charge the battery.
3. Do not incinerate the Lithium battery or expose it to excessive heat.
4. Do not short-circuit, puncture, crush, disassemble, damage, force over-discharge (reversal) or modify the battery.
5. Do not expose the battery to water or moisture.
6. Do not drop or subject the battery to strong impacts.
7. Only use the battery specified in this manual.
8. Only use the specified, battery charging unit or DC-in jack to charge the battery.
9. Do not use a leaking battery.
10. If charging is not completed within the specified time period, unplug the charger and discontinue charging immediately.
11. The charger and battery temperature rises with extended periods of use. Care should be taken to avoid burns.
12. Burns may result if the battery is removed immediately after extended periods of use.
13. If fluid from the battery enters your eye, immediately rinse the eye with plenty of fresh water and contact a doctor. If fluid from the battery makes contact with your skin or clothing, wash the area thoroughly with water.

## **2. General Description**

VWR Signature electronic pipettors feature an accurate and efficient, as well as ergonomic and light-weight design. Researchers can program these state-of-the-art products to conduct different pipetting tasks. More accurate and comfortable pipetting can be easily achieved without any concern of finger stress or injury.

### **2.1. Features**

- High accuracy and precision
- Low forces
- Useful, practical operation protocols, such as Automatic Pipetting (AUTO) with Mixing (MIX) option, Multiple Dispensing (MD), Mixing (MIX) and Sequential Aspirating/Dispensing (SE), etc.
- 9 user-defined program sets
- 5 speeds for aspirating and dispensing
- Li-ion battery provides extended use on a single battery charge
- Ergonomic design
- Automatic calibration
- User-friendly graphic operation interface.
- Adjustable tip ejector.
- Automatically remembers the last-used pipetting protocol and settings
- Complies with CE, ISO-8655, GLP



## 2.2. Ranges and Specifications

Product No.	Channels	Volume Range ( $\mu$ l)	Increment ( $\mu$ l)	Accuracy (Rel. $\pm$ )	Precision (Rel. CV $\leq$ )
SE10-1	1	0.5 -10	0.1	4.0-1.0%	2.5-0.4%
SE20-1	1	2 -20	0.1	5.0-1.0%	2.0-0.3%
SE200-1	1	10 -200	1	2.0-0.6%	1.0-0.15%
SE1200-1	1	100 -1,200	1	1.5-0.5%	0.6-0.15%
SE10-8	8	0.5-10	0.1	4.0-1.0%	2.5-0.4%
SE20-8	8	2-20	0.1	5.0-1.0%	2.0-0.3%
SE200-8	8	10-200	1	2.0-0.6%	1.0-0.15%
SE1200-8	8	100 -1,200	1	1.5-0.5%	0.6-0.15%

**Note:**

*VWR Signature electronic pipette Accuracy and Precision Specifications have been attained using VWR Signature pipette tips. VWR guarantees Accuracy and Precision only if VWR Signature tips or other approved tips are used.*

## 3. Getting Started

### 3.1. Unpacking

Open the VWR Signature electronic pipettor package and confirm that all items are included:

- Single/8-channel VWR electronic pipette unit
- Operation manual

- Quality assurance card
- VWR electronic pipette hanger and accessories
- AC-DC power adaptor
- Pipette tips

If there are any items missing, damaged, or not according to your order, please contact your distributor or sales representatives for replacement immediately.

Please charge the battery before first-time operation.

### 3.2. Inserting the Battery

Remove the battery cover by pressing the battery cover latch (see Figure 1) and move the cover outward. Insert the battery (see Figure 2). Metallic contacts must be face down. Close the cover of the battery compartment. Press the **RESET** button to power on and calibrate the VWR electronic pipette.

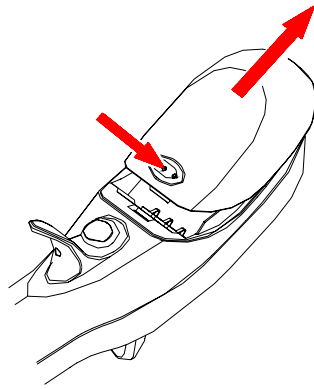

Figure 1: Open the battery cover.

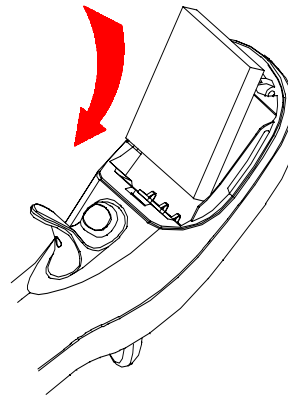



Figure 2: Insert the battery.

*Note: After a charged battery is inserted, the VWR electronic pipette will automatically carry out a calibration routine.*

### **3.3. Charging the Battery**

There are two ways to charge the battery: (1) Attach the included AC-DC Power Adapter to the pipettor (2) Use the optional battery charging kit.

#### **Included AC-DC Power Adapter**

Insert the battery into the battery compartment. Insert the DC-in plug of the power adaptor into the DC-in jack (see Figure 3). Connect the power plug of the power adaptor with the external power source. **Connecting the power plug before inserting the battery will inactivate the charging process.** The indication bar inside battery symbol  will blink during the charging process. When the battery is fully charged, the blinking will stop and the VWR electronic pipette will beep once to remind the user.

#### **Optional Charging Kit**

Connect the power plug of the charging unit to the proper external power source. The indication light will turn green. Insert the battery (see Figure 4). Once the battery is correctly inserted and charging, the indicator light will turn red. When the battery capacity is full, the indicator light will turn green again.

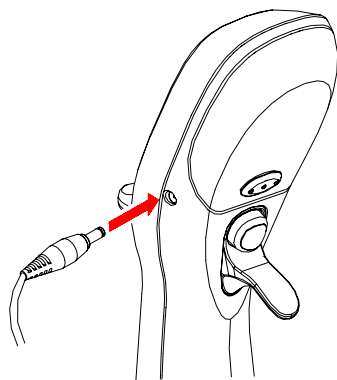

Figure 3: Using the included AC-DC adapter to charge the battery

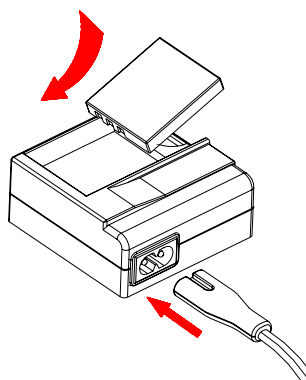

Figure 4: Using the optional charging kit to charge the battery

**Note:**

1. *For safety reasons, the VWR Signature electronic pipettors cannot be used during charging.*
2. *Please do not over-charge the battery for a long period of time.*

### 3.4. Start Pipetting

There is no power On/Off button on the VWR Signature electronic pipettors. Once users insert the fully-charged battery, the pipettor will be switched on. It will perform a calibration routine and switch on the LCD display as in Figure 8. Press any keypad button or the **PLUNGER** button to enter the function mode selection. The VWR Signature electronic pipettor will be automatically powered off if it's not in use for more than 10 minutes.

Select the desired function mode and settings (refer to the following chapters : 6 ~ 10 ) before pipetting. After the initial set-up, attach the correct-sized tips to the cone(s) of the pipette before operation.

Product No.	Channels	Volume Range ( $\mu$ l)	Correct Pipette Tip Size
SE10-1	1	0.5 -10	10 $\mu$ l
SE20-1	1	2 -20	10 $\mu$ l
SE200-1	1	10 -200	200 $\mu$ l
SE1200-1	1	100 -1,200	1000 $\mu$ l
SE10-8	8	0.5 -10	10 $\mu$ l
SE20-8	8	2-20	10 $\mu$ l
SE200-8	8	10-200	200 $\mu$ l
SE1200-8	8	100 -1,200	1000 $\mu$ l

The cones of the VWR Signature electronic pipettor are designed to fit a wide variety of manufacturers pipette tips. However, the published accuracy and precision specifications for the VWR Signature electronic pipettors are guaranteed only when using VWR Signature tips. Contact VWR International for pipette tip ordering information.

The VWR Signature electronic pipettor is an ergonomic instrument designed to reduce hand fatigue and repetitive stress injury. In order to maximize the benefits of the VWR Signature electronic pipettor's design, the instrument should be held as shown in figure 5. Use your index finger to press the **PLUNGER** button and use your thumb to press the **TIP** ejector.

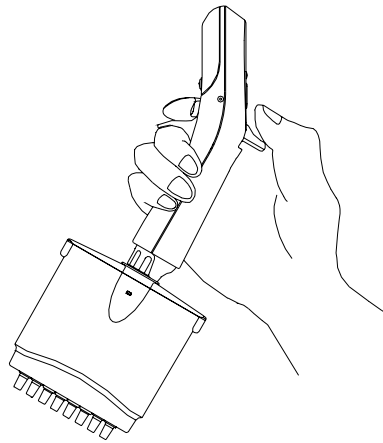

Figure 5: Correct hand position

### 3.5. Manual Blow-out Operation

The automatic blow-out function, in different pipetting modes, simulates the blow-out function in manual pipettes. With the Blow-out function selected, the user can press the **PLUNGER** button once to dispense the liquid and the piston will travel an extra distance to blow out any remaining liquid. The piston will then pause and return to its starting position. Alternatively the user can press and hold the **PLUNGER** button to dispense. The piston will travel the extra distance to blow out remaining liquid and remain in that position until the plunger is released. Only when the **PLUNGER** button is released, the piston will return back to its starting position.

### 3.6. Hanger Installation

The VWR Signature electronic pipettor hanger can be attached to a shelf or counter using the sticker as shown in Figure 6. The finger rest of the VWR Signature electronic pipettor locks into the hanger and keeps the pipettor in a vertical position.

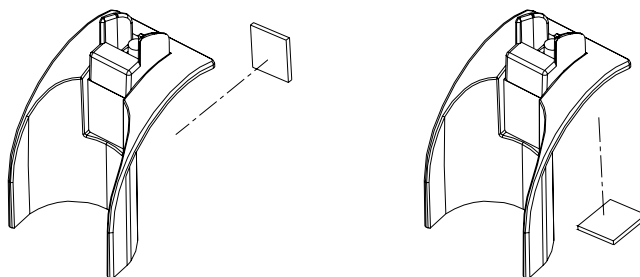

Figure 6: VWR Signature electronic pipettor hanger installation

#### 4. VWR Signature electronic pipettor Overview

This section presents an overview of the VWR Signature electronic pipettor's various components and buttons (see Figure 7) as well as the symbols and indicators on the LCD display (see Figure 8).

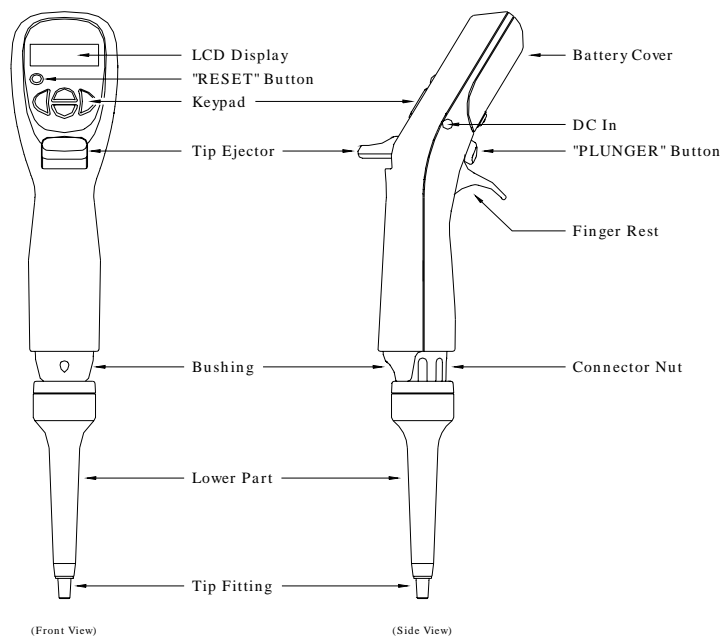

Figure 7: 1-channel VWR Signature electronic pipettor overview



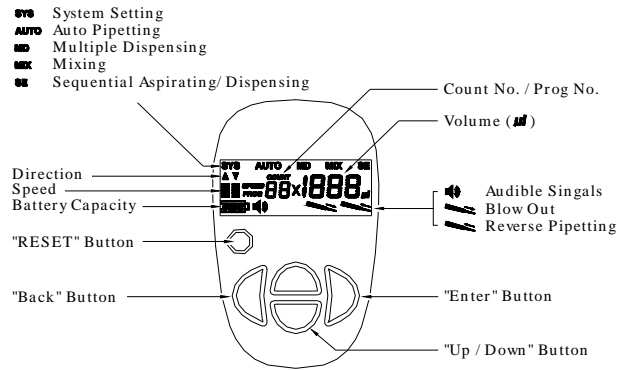





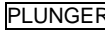



Figure 8: LCD display Panel

#### 4.1. Keypad Function

Button	Symbol	Function Description
Set/Enter		Confirms your choice
Exit/Esc		Exits to previous mode/setting
Up		Increases volume/ changes parameter
Down		Decreases volume/ changes parameter
Reset		Piston automatically determines the home position
PLUNGER		Activates aspirating/dispensing/ same as  button
Tip Ejector		Ejects the tips

***Tips for Efficient Operation:** The **PLUNGER** button can be used to increase volumes and to change modes and settings same as the “Up” button during the function mode selection and volume settings. This operation feature can speed up the setting processes.*

#### **4.2. Audible Signals**

The audible signals are beneficial when you are familiarizing yourself with the operating procedure of the VWR Signature electronic pipettor. They can also be switched off if desired (see Section 6.3.)

<b>Audible Sound</b>	<b>Operation</b>
Low-tone beep	Aspirating
High-tone beep	Dispensing/ Tip Ejection/ Error codes
2 beeps	MD/MIX/SE mode cycle or RESET routine is completed

## 5. Function Map

The main menu of the VWR Signature electronic pipettor includes five function modes (SYS, AUTO, MD, MIX and SE). Each mode includes various function settings (see Figure 9).

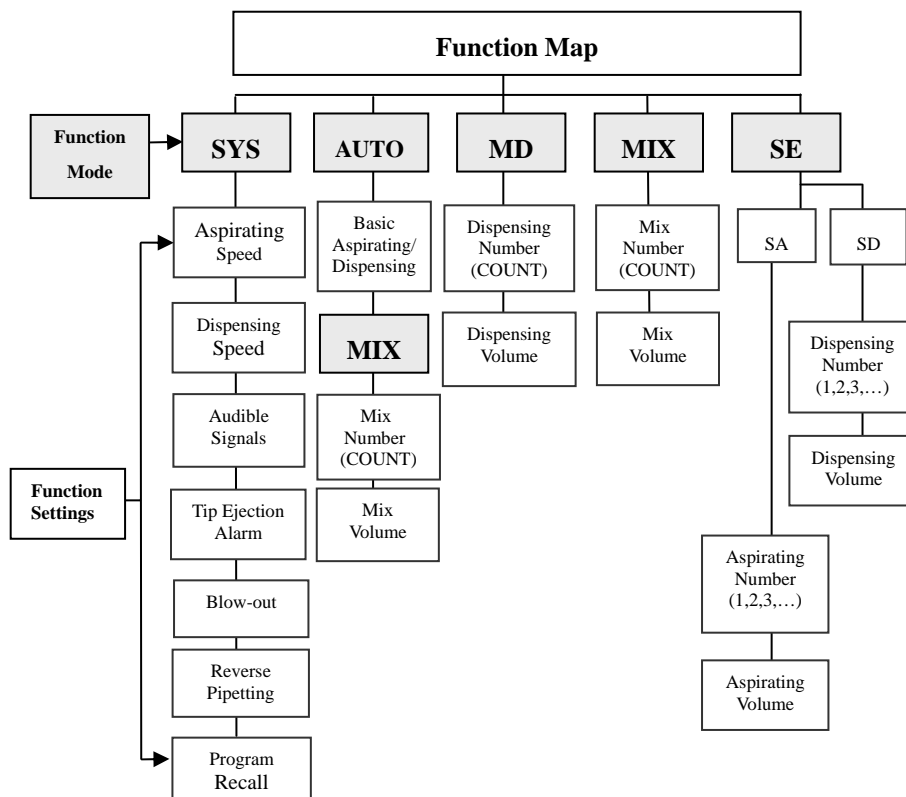



Figure 9: Function map

## 9. SYS (System) Mode









SYS mode is used to set up the function settings before pipetting. Once users select and store these settings, they will no longer need to set up the settings before every pipetting. There are 6 function settings (Aspirating Speed, Dispensing Speed, Audible Signals, Blow-out, Reverse Pipetting and Program Recall) in SYS mode.

### *Note :*





1. *These 6 function settings are sequential procedures. To store these settings in memory, users have to complete the whole setting procedure and press  «SET» when the LCD displays **PROG** .*
2. *Users can use the  «Up/Down» button to move back and forth to the previous function settings.*

### 6.1. Aspirating Speed

There are 5 speeds available for both aspirating and dispensing:





1. Press  «EXIT» to enter the function mode selection. Then press  «Up/Down» to select the **SYS** symbol (flashing).
2. Press  «SET» to confirm the selection of **SYS** mode and the aspirating speed symbol  will start flashing.
3. Press  «Up/Down» to change the aspirating speed (  : Slowest,  : Fastest).
4. Press  «SET» to confirm the speed selection and move to the “Dispensing Speed” function setting.

## 6.2. Dispensing Speed

1. The “Dispensing Speed” symbol  should now be flashing.
2. Press  «Up/Down» to change the aspirating speed (  : Slowest,  : Fastest).
3. Press  «SET» to confirm the speed selection and move to the “Audible Signals” function setting.





## 6.3. Audible Signals





Please refer to Section 4.2 for the definition of “Audible Signals”.

1. The “Audible Signals” symbol  should now be flashing.
2. Press  «Up/Down» to select the preference (  : On,  : Off).
3. Press  «SET» to confirm the selection and move to the “Tip Ejection Alarm” setting.

## 6.4. Blow-out

The automatic blow-out function, in different pipetting modes, simulates the blow-out function in manual pipettes. **To avoid the leftover final droplet in tips, the blow-out setting is recommended in all protocols.** The blow-out setting will not be performed in “Reverse Pipetting” setting.





1. The “Blow-out” symbol  should now be flashing.
2. Press  «Up/Down» to select the preference (  : On,  : Off).

3. If  is selected, pressing  «SET» will confirm the selection and move to the “PROG” setting. If  is selected, pressing  «SET» will confirm the selection and move to the “Reverse Pipetting” setting.

**Note:** *It is important to withdraw the tip quickly from the dispensed sample vessel after dispensing if Blow-out is selected, because the piston will automatically retract a short distance. By holding the **PLUNGER** button during dispensing, the piston will travel the distance to blow out, and remain there until the **PLUNGER** button is released.*

## 6.5. Reverse Pipetting

The automatic reverse pipetting, in different pipetting modes, is to reserve the final drop of sample. The VWR Signature electronic pipettor will not perform reverse pipetting in MIX or SE modes.



1. The “Reverse Pipetting” symbol  should now be flashing.
2. Press  «Up/Down» to choose the preference ( : On, : Off).
3. Press  «SET» to confirm the selection and move to the “PROG” setting.

**Note:** *If Reverse Pipetting is selected, users have to press the **PLUNGER** button one more time after pipetting to dispense the remaining liquid during the pipetting. **rE** will appear on the LCD to remind users to dispense the remaining liquid.*





## 6.6. Setting PROG (Programs)

The memory program includes 9 different storage locations (PROG 01 ~ 09). Your favorite operating modes with user-selected settings can be stored to these locations for future recalls. Before setting the programs, you must have programmed operating mode (e.g. AUTO, MD mode, etc).

### Store Operating Mode to Storage Locations

1. Complete the setup of function mode (e.g. AUTO, MD, MIX mode).
2. Press and hold  «SET» for 3 seconds to enter PROG mode.
3. Press  «Up/Down» to select PROG number from 01 ~ 09.
4. Press  «SET» to confirm the location selection and save the functions.

### Recall Stored Programs from the Storage Location

1. Press  «EXIT» to enter the function mode selection. Then press  «Up/Down» until the **SYS** symbol starts flashing.
2. Press  «SET» repeatedly to confirm the selection of all 6 function settings until the **PROG** symbol starts flashing.
3. Press  «Up/Down» to select the PROG number.
4. Press  «SET» to confirm the selection.
5. Press the **PLUNGER** button to operate the VWR Signature electronic pipettor in the selected program.





*Note: During the recall process, the changes of other settings will not be stored.*

## 7. AUTO Mode

AUTO mode includes ; 1) AUTO mode only and 2) AUTO + MIX mode. In AUTO mode only, the VWR Signature electronic pipettor performs the aspirating and dispensing of a set liquid volume. In AUTO + MIX mode, the VWR Signature electronic pipettor performs mixing after automatic pipetting is completed. This mode is ideal for serial dilution applications.



### 7.1. AUTO mode only

Please follow the steps below to set up the automatic pipette volume.







1. Press  «EXIT» to enter the mode selection, which causes the **AUTO** symbol to start flashing. If not, press  «Up/Down» to select AUTO mode.
2. Press  «SET» to confirm the mode selection.
3. Use  «Up/Down» to select the desired pipetting volume.
4. Press  «SET» to confirm selected volume and the VWR electronic pipette is ready for pipetting.

*Tip:* Users can use the **PLUNGER** button instead of  «Up» to speed up the volume setting.

### 7.2. AUTO + MIX mode

1. Press  «EXIT» to enter the mode selection, which causes the **AUTO** symbol to start flashing. If not, press  «Up/Down» to select AUTO mode.









2. Press and hold  «SET» for 2 seconds to enter AUTO + MIX mode selection. Both AUTO and MIX symbols will appear. The pipetting volume will appear and start flashing.
3. Use  «Up/Down» to select the desired pipetting volume.
4. Press  «SET» to confirm selected volume and enter MIX mode setting. The **COUNT** symbol will start flashing.
5. Press  «Up/Down» to select the desired mixing cycle counts.
6. Press  «SET» to confirm selected mixing cycle counts. The mixing volume will start flashing.
7. Press  «Up/Down» to select the desired mixing volume.
8. Press  «SET» to confirm selected mixing volume.

Press the PLUNGER button to aspirate the sample. Press the PLUNGER button again to dispense the sample and the LCD will display the mixing cycle counts and volume. Press the PLUNGER to mix and dispense the sample. In the end of mixing, sample will remain in the tip and LCD will display **⌂**. Press the PLUNGER to dispense the remaining sample with blow-out function.

## 8. MD (Multiple Dispensing) Mode

In MD mode, the VWR Signature electronic pipettor performs repetitive dispensing of a selected volume. **When using Multiple Dispensing (MD) mode, users “MUST” select Reverse Pipetting in the System (SYS) settings.** Reverse Pipetting is used in Multiple Dispensing (MD) mode to provide better accuracy and precision with repeated dispensing. Reverse Pipetting means that an extra volume of liquid will be left in the tip at the end of a multiple dispensing cycle, and the display will show **rE** to remind the user to dispense this residual volume before repeating the multiple dispense cycle.







1. Press  «EXIT» to enter the mode selection.
2. Press  «Up/Down» to make the **MD** symbol flash.
3. Press  «SET» to confirm the selection. The **COUNT** symbol will then appear.
4. Use  «Up/Down» to select the desired pipetting count.
5. Press  «SET» to confirm the selection of count. The default pipetting volume will start flashing.
6. Use  «Up/Down» to select the desired pipetting volume.
7. Press  «SET» to confirm the pipetting volume. The pipetting volume will show the total aspirating volume.

After the settings are completed, first press the **PLUNGER** button to aspirate the sample according to the pipetting volume. Then press the **PLUNGER** button repeatedly to dispense the samples according to the pipetting counts. For the last count, you will hear two beeps to indicate that the next dispense is the last and the display will show **rE** to remind the user to press the **PLUNGER** button and dispense the extra remaining amount of liquid. After

completing the Multiple Dispensing cycle, pressing the **PLUNGER** button again will aspirate liquid into the tip and repeat the set MD cycle.

## 9. MIX Mode

After the settings are completed (see instructions below), Mixing is performed automatically by pressing the **PLUNGER** button once.

1. Press  «EXIT» to enter mode selection.
2. Press  «Up/Down» repeatedly until the **MIX** symbol starts flashing.
3. Press  «SET» to confirm the selection. The **COUNT** symbol will then appear.
4. Use  «Up/Down» to select the desired mixing count.
5. Press  «SET» to confirm the selection. The default pipetting volume will start flashing.
6. Use  «Up/Down» to select the desired mixing volume.
7. Press  «SET» to confirm the selection. The total mixing volume and counts will be displayed.

Press the **PLUNGER** button to start the mixing function. After the completion of mixing, pressing the **PLUNGER** button will re-activate the mixing process until the user changes the function mode.









## 10. SE (Sequential Aspirating/Dispensing) Mode

SE mode includes SA (Sequential Aspirating) mode and SD (Sequential Dispensing) mode.

## 10.1. SA (Sequential Aspirating) Mode

**Not available on 1200ul models because the diameter of 1000/1200ul tips does not allow the required air gap to be maintained.**

The VWR Signature electronic pipettor performs repetitive aspirations of the selected volumes. An air gap will be created automatically between two aspirations. When the sequential aspiration is completed, the next operation will dispense all of the aspiration volume together.

1. Press  «EXIT» to enter function mode selection.
2. Press  «Up/Down» repeatedly until the **SE** symbol starts flashing.
3. Press  «SET» to confirm the selection.
4. Use  «Up/Down» until the **SA** symbol starts flashing.
5. Press  «SET» to confirm the selection.
6. Under the **COUNT** symbol, “01” will appear. Press  «Up/Down» to set the volume of the first aspiration.
7. Press  «SET» to confirm the selection.
8. Repeat steps 6 and 7 to set the sequential aspiration volumes. The total aspirating volume (including air gap volume) cannot exceed maximum volume range.
9. Press  «SET» to confirm the selection.
10. The count “01” and aspirating volume will appear on the display. The pipetting direction and speed  will flash to indicate that the VWR electronic pipette is ready for liquid pick-up. Press the PLUNGER button to aspirate the samples. **A** will appear to remind users to create an air gap (by pressing the PLUNGER button with the tip out of the sample) between sample aspirations.





11. When the aspirations are completed, the VWR Signature electronic pipettor will make two beeping sounds and  will flash to indicate the VWR electronic pipette is ready for dispensing.
12. After the sequential aspirating cycle has been completed and the liquid has been dispensed, pressing the **PLUNGER** button will re-activate the whole cycle again until users change the function mode.







**Note:**

1. *If the blow-out setting is selected, the VWR Signature electronic pipettor will automatically blow-out the liquid during sequential aspiration mode.*
2. *1200ul models do not include the Sequential Aspirating (SA) function, because the air gap is not strong enough to support the weight of samples.*
3. *Sequential Aspirating (SA) function will not perform Reverse Pipetting even if it is selected in System (SYS) mode.*

## **10.2. SD (Sequential Dispensing) Mode**

The VWR Signature electronic pipettor performs repetitive dispensing of various selected volumes. As with Multiple Dispensing mode, for best accuracy in SD Mode, it is recommended to select Reverse Pipetting in System Mode.

1. Press  «EXIT» to enter function mode selection.
2. Press  «Up/Down» repeatedly until **SE** symbol starts flashing.
3. Press  «SET» to confirm the selection.
4. Press  «Up/Down» repeatedly until **Sd** symbol starts flashing.

5. Press  «SET» to confirm the selection.
6. Under **COUNT** symbol, “01” will appear. Press  «Up/Down» to set the volume of the first dispense.
7. Press  «SET» to confirm the selection.
8. Repeat steps 6 and 7 to set the sequential dispensing volumes. The total dispensing volume cannot exceed the maximum volume range.
9. Press  «SET» to confirm the selection.
10. The count “01” and the total aspirating volume will appear on the display. The pipetting direction and speed  will flash to indicate the VWR Signature electronic pipettor is ready for liquid pick-up. Press the PLUNGER button to aspirate the sample. When the aspiration is completed, the dispensing count and volume will appear and  will flash to indicate that the VWR Signature electronic pipettor is ready for dispensing.
11. The VWR Signature electronic pipettor will make two beeping sounds to remind the user of the last measured volume to dispense. At the end of the sequential dispensing cycle, if Reverse Pipette mode is selected,  will be displayed to remind the user to press PLUNGER button to dispense the remaining extra amount of sample. After completing the dispensing, pressing the PLUNGER button again will re-activate the whole cycle until the user changes the function mode.

***Note:** If the blow-out setting is selected, the VWR Signature electronic pipettor will automatically blow-out the liquid at the end of a sequential dispensing cycle.*

## 11. Sterilization

Only the lower piston assembly of VWR Signature electronic pipettor can be steam-autoclaved (121°C, 1 bar, 20 minutes). NOTE: It is important not to exceed the the temperature of 121°C or 20 minute time during the autoclaving cycle. Autoclaving at a higher temperature or for longer period of time will damage the manifold and void the warranty. The autoclaved parts must be allowed to dry completely at room temperature for at least 2 hours before reassembly. Users can follow Figures 11~14 to disassemble the VWR Signature electronic pipettor. Please “DO NOT” use excessive force to pull down the lower part before releasing the cylinder lock as shown in Figure 10. This action will break the connection mechanism of the lower part, permanently damaging the instrument and will void the warranty.

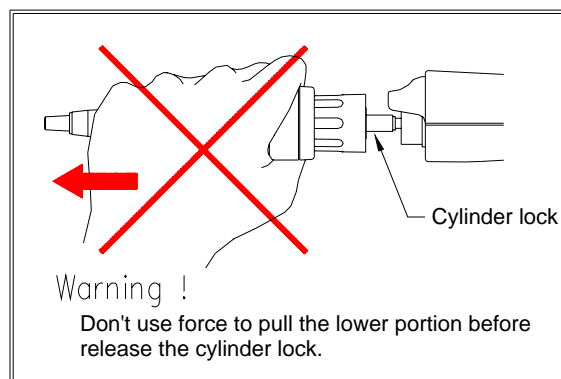

Figure 10: Incorrect removal of the lower piston assembly.

### 11.1. Removal of the Lower Piston Assembly



Always remember to press **RESET** button before you disassemble the lower part of VWR Signature electronic pipettor.

1. Press the **RESET** button. Wait until you hear two beeps.
2. Loosen the lower part of VWR Signature electronic pipettor by unscrewing the connecting nut in counter-clockwise direction as shown in Figure 11.
3. Pull the lower piston assembly downward slowly until the metal cylinder lock appears as shown in Figure 12.
4. **Lay the VWR Signature electronic pipettor down on a flat surface.** Push the metal cylinder lock downward until you hear a click sound as shown in Figure 13.
5. The lower piston assembly will come off easily and automatically as shown in Figure 14.

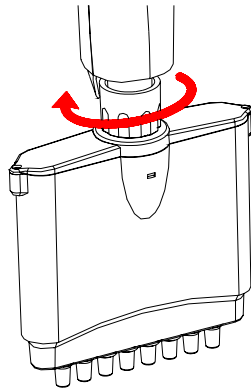

Figure 11: Loosen the connecting nut by unscrewing counter-clockwise.

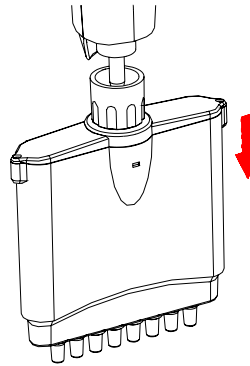

Figure 12: Pull the lower piston assembly downward slowly until the cylinder lock appears.



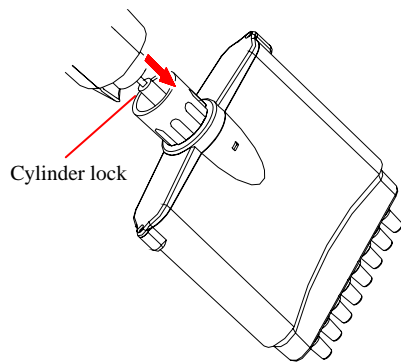

Figure 13: Push the metal cylinder lock downward until you hear a click sound.

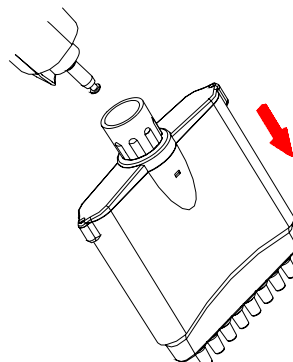

Figure 14: The lower piston assembly will come off easily and automatically.

## 11.2. Reattach the lower piston assembly



Always remember to press **RESET** button after you reattach the lower piston assembly of VWR Signature electronic pipettor.

Follow these steps to reassemble VWR Signature electronic pipettor:

1. Press the **PLUNGER** button or any button of the keypad to make the step motor shaft retract about 1cm back into the handle. The step motor will automatically retract inside if users do not touch any button for 10 minutes.
2. Connect the lower part with connecting nut. Tighten up the connecting nut.

3. Press the **RESET** button. The step motor shaft will connect with the piston of the lower part automatically. After the connection is completed, the VWR Signature electronic pipettor will beep twice.

## 12. Maintenance

The outside of VWR Signature electronic pipettor may be wiped clean with 60% Isopropanol, 70% ethanol or mild detergent, and then wiped dry with a lint-free cloth. If the pipette is severely contaminated or if very corrosive chemicals are dispensed, the lower part of the VWR electronic pipette should be disassembled. The individual parts should be rinsed in distilled water and then air dried. For complete information on proper disassembly of the VWR Signature electronic pipettor, contact VWR 's service department.

It is recommended to clean the VWR Signature electronic pipettor at regular intervals depending on how much the pipette is used, as well as lubricating it once per year. If the pipette is autoclaved often, you may need to lubricate the pipette more frequently. Lubrication of the piston should be performed only by authorized VWR service personnel, or trained users, and only the proper VWR Signature electronic pipettor lubricant available from VWR International should be used\*. For complete information on proper service of your VWR Signature electronic pipettor, contact VWR International's Service Department.



It is recommended to check the performance of your VWR Signature electronic pipettor regularly (e.g. every 3 ~ 6 months) and always after maintenance or service. More frequent testing of the VWR Signature electronic pipettor may be desired depending upon requirements of the application, frequency of use, number of operators using the pipette, nature of the liquid dispensed and the acceptable maximum permissible errors established by the user (ISO 8655-1). For more information of VWR Signature electronic pipettor calibration procedures, contact VWR's Technical Support Department.

*\*Note: Using improper lubricants will deter or block the movement of VWR electronic pipette's piston.*

### 13. Troubleshooting

To ensure the product's quality and performance, the VWR Signature electronic pipettor is designed with a self-diagnosis program. This program will constantly monitor the accuracy of pipetting volume, battery status and auto-calibration function. Error (Err) messages will appear on the display if the VWR Signature electronic pipettor fails to perform the attempted action properly. In the case of Error (Err) messages or faults, please refer to the solutions in the following table to clear the error messages or faults.

If the following solutions are not able to resolve the problem, please contact VWR International's Service Department to arrange for authorized service.

Symptom	Possible Cause	Solution
"Err 01"	Bad battery	Charge the battery
	Bad power adaptor	Replace the power adaptor
"Err 02"	Auto-calibration is not working	Press the  button
"Err 03"	Inaccurate pipetting volume	Press the  button
"Err 04"	Step motor failure	Press the  button
	Photo-couple failure	
Droplets left inside the tip	Unsuitable tip	Use quality, low retention tips
Leakage or volume too small	Non-uniform wetting of the plastic tip	Rinse the tip once prior to pipetting

	Tip incorrectly attached	Attach firmly
	Unsuitable tip	Use high-quality tips
Failure to aspirate	Low battery	Charge the battery
	The lower manifold is not correctly attached	Detach and reassemble
	Foreign material blocking the hole at bottom of the cone	Use MIX mode and distilled water to wash. Air dry
	Piston movement is blocked	Lubricate piston
Power on failure	Bad battery contact	Reinsert the battery
	Rusted battery contact	Replace with new battery
	Dead battery	Charge the battery
Function Mode setup failure	Tip Ejector can't bounce back	Adjust Tip Ejector position

## Appendix A: Technical Specifications

<b>Operation Mode</b>	Automatic Pipetting (AUTO), Multiple Dispensing (MD), Mixing(MIX) Sequential Aspirating/Dispensing (SE), System Setup (SYS)
<b>Program memory</b>	9 programs
<b>Aspirating/Dispensing Speed</b>	5 speeds
<b>Auto-calibration</b>	Yes
<b>Piston Motor</b>	High precision stepping motor
<b>Power Saving Feature</b>	Yes, after 10 minutes
<b>Power Adaptor</b>	100/120/220/240 V AC-DC 3.6 V
<b>Audible Alerts</b>	Yes
<b>Autoclavable</b>	Yes, lower manifold only
<b>Operating Temperature</b>	5 ~ 50°C
<b>Operating Humidity</b>	RH: 0 ~ 85%
<b>Battery</b>	900 mAh/3.6 V or above, Li-Ion
<b>Battery Charger Kit</b>	Optional
<b>Carrousel Stand</b>	Optional
<b>Certification</b>	Complies with CE, Class A (EN60101-1-2, EN50082-1, EN 55011) Complies with ISO-8655/ DIN 12650

### *Note:*

1. *U.S. patents pending*
2. *Specifications are subject to change without prior notice*

## Appendix B : Tip Ejector Height Adjustment

Use a flat-head screw driver or other tool to turn the tip ejector height adjustment screw as shown in Figure 15. By turning the screw in a counter-clockwise direction, the tip ejector can be adjusted down. This height adjustment feature enables efficient ejecting of different manufacturer's tips.

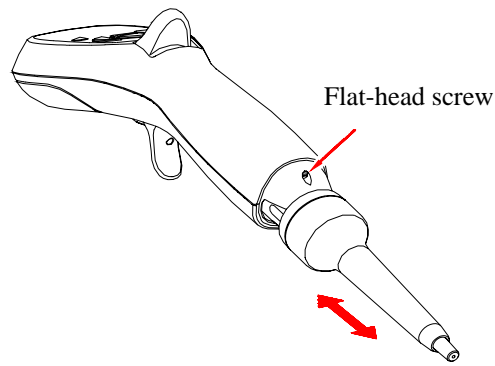

Figure 15 Tip ejector height adjustment

### **Appendix C: Warranty**

VWR Signature electronic pipettors are covered by a warranty for one year against defects in materials and workmanship. This period begins from the date of purchase, and within this period all defective parts will be replaced at no charge by VWR International. The warranty does not cover defects caused by excessive wear and tear or damage due to shipping, accident, abuse, misuse, problems with electrical power, or usage not in accordance with product instructions, or if other than original spare parts supplied by the manufacturer have been used. Each VWR Signature electronic pipettor is tested and documented by the manufacturer before shipping. VWR's Quality Control System guarantees that the performance of the VWR Signature electronic pipettor you have purchased is within its specifications.

**Note**



**Note**





VWR International Inc., 1310 Goshen Parkway, West Chester, PA 19380, USA

US Toll Free: 800-932-5000

E-mail: [sales @vwr.com](mailto:sales@vwr.com)

Web Site: [www.vwr.com](http://www.vwr.com)