



# New Brunswick™ LN<sub>2</sub> Back-up System

Operating manual

## **Copyright**

Copyright © 2014 Eppendorf AG, Germany. No part of this publication may be reproduced without the prior permission of the copyright owner.

The company reserves the right to change information in this document without notice. Updates to information in this document reflect our commitment to continuing product development and improvement.

## **Trademarks**

Eppendorf® and the Eppendorf logo are registered trademarks of Eppendorf AG, Germany.

New Brunswick™ and the New Brunswick™ Logo are trademarks of Eppendorf AG, Germany.

Innova® is a registered trademark of Eppendorf, Inc., USA.

Trademarks are not marked in all cases with ™ or ® in this manual.

Eppendorf has attempted to identify the ownership of all trademarks from public records. Any omissions or errors are unintentional.

## Table of contents

<b>1</b>	<b>Operating instructions</b>	<b>5</b>
1.1	Using this manual	5
1.2	Danger symbols and danger levels	5
1.2.1	Hazard icons	5
1.2.2	Degrees of danger	5
1.3	Symbols used	5
<b>2</b>	<b>Safety</b>	<b>7</b>
2.1	Intended use	7
2.2	User profile	7
2.3	Information on product liability	7
2.4	Warnings for intended use	7
2.4.1	Personal injury and damage to device	7
2.4.2	Incorrect handling of accessories	8
<b>3</b>	<b>Product description</b>	<b>9</b>
3.1	Main illustration	9
<b>4</b>	<b>Transport, storage and disposal</b>	<b>11</b>
4.1	Transport	11
4.2	Disposal	11
<b>5</b>	<b>Introduction</b>	<b>13</b>
5.1	Scope of manual	13
5.2	LN <sub>2</sub> Back-up System	13
5.3	Product versions	13
<b>6</b>	<b>Installation</b>	<b>15</b>
6.1	Before installation	15
6.2	Selecting the location	15
6.3	Unpacking the device	15
6.4	Temperature sensor installation	16
6.4.1	Temperature sensor installation for upright freezers	16
6.4.2	Temperature sensor installation for chest freezers	16
6.5	Installing the insulated transfer hose	17
6.5.1	For upright freezers (including Model U101)	17
6.5.2	For chest freezers	17
6.6	Solenoid valve to freezer installation	17
6.6.1	Solenoid valve installation for upright freezers	17
6.6.2	Solenoid valve installation for chest freezers	18
6.7	LN <sub>2</sub> gas supply installation	18
6.8	Test for gas leaks	18
6.9	Door switch installation	19
6.10	Installing cables to back of control unit	20
<b>7</b>	<b>Operation</b>	<b>21</b>
7.1	Turning the control unit on	21
7.2	Testing the solenoid valve	21

**Table of contents**

New Brunswick LN2 Back-up System  
English (EN)

7.3	Testing door switch . . . . .	21
7.4	Testing back-up system operation . . . . .	22
7.5	Battery back-up . . . . .	22
7.6	Alarm system monitoring socket . . . . .	23
<b>8</b>	<b>Maintenance . . . . .</b>	<b>25</b>
8.1	Cleaning . . . . .	25
8.1.1	Cleaning the device . . . . .	25
8.1.2	Cleaning the surrounding area . . . . .	25
8.2	LN <sub>2</sub> supplies . . . . .	25
8.3	Electrical connection maintenance . . . . .	26
8.4	Battery maintenance . . . . .	26
8.5	Transfer line and manifold maintenance . . . . .	26
8.6	Maintenance forms . . . . .	27
8.7	CO <sub>2</sub> /LN <sub>2</sub> back-up system service checklist . . . . .	27
<b>9</b>	<b>Technical data . . . . .</b>	<b>29</b>
9.1	Performance . . . . .	29
9.2	Weight/dimensions . . . . .	29
9.2.1	Device dimensions . . . . .	29
9.2.2	Device weight . . . . .	29
9.3	Cable and transfer line lengths . . . . .	29
9.4	Power supply . . . . .	29
9.5	Fuses . . . . .	29
9.6	Ambient conditions . . . . .	30
9.6.1	Device operating environment . . . . .	30
9.7	Gas Consumption . . . . .	30
9.8	LN <sub>2</sub> Supplies . . . . .	31
9.9	Spare parts . . . . .	31
9.10	Circuit Schematics . . . . .	33
<b>10</b>	<b>Declaration of conformity . . . . .</b>	<b>35</b>
	<b>Index . . . . .</b>	<b>37</b>





# 1 Operating instructions

## 1.1 Using this manual

- ▶ Carefully read this operating manual before using the device for the first time.
- ▶ Also observe the operating manual enclosed with the accessories.
- ▶ This operating manual should be considered part of the product and stored in a location that is easily accessible.
- ▶ Include this operating manual when forwarding the device to third parties.
- ▶ If this manual is lost, please request another one. The latest version can be found on our website [www.eppendorf.com](http://www.eppendorf.com) (international) or [www.eppendorfn.com](http://www.eppendorfn.com) (North America).

## 1.2 Danger symbols and danger levels

### 1.2.1 Hazard icons

	Material damage		Freezer burn
	Hazard point		Electric shock

### 1.2.2 Degrees of danger

The following danger levels are used in safety messages throughout this manual.

<b>DANGER</b>	<i>Will</i> lead to severe injuries or death.
<b>WARNING</b>	<i>May</i> lead to severe injuries or death.
<b>CAUTION</b>	May lead to light to moderate injuries.
<b>NOTICE</b>	May lead to material damage.

## 1.3 Symbols used

Depiction	Meaning
▶	You are requested to perform an action.
1. 2.	Perform these actions in the sequence described.
•	List
<i>Text</i>	Terms and labels of the graphic user interface.
	References useful information.

**Operating instructions**

New Brunswick LN2 Back-up System  
English (EN)

## 2 Safety

### 2.1 Intended use

The LN<sub>2</sub> Back-up System is exclusively intended for indoor use and for and to maintain inside temperature of all Innova and Premium freezers in case of power failure.

### 2.2 User profile

The device may only be operated by trained lab personnel who have carefully read this operating manual and are familiar with the device functions.

### 2.3 Information on product liability

In the following cases, the designated protection of the device may be compromised.

The liability for the function of the device passes to the operator if:

- The device is not used in accordance with this operating manual.
- The device is used outside of the range of application described in the succeeding chapters.
- The device is used with accessories or consumables that were not approved by Eppendorf.
- Service or maintenance is completed on the device by people who are not authorized by Eppendorf.
- The owner has made unauthorized modifications to the device.

### 2.4 Warnings for intended use

Before using the device, read this operating manual and observe the following general safety instructions.

#### 2.4.1 Personal injury and damage to device



**WARNING! Electric shock due to damage to the device or power cable**

- ▶ Only switch on the device if the device and power cable are undamaged.
- ▶ Only use devices that have been properly installed or repaired.



**WARNING! Danger due to incorrect power supply**

- ▶ Only connect the device to voltage sources that meet the requirements on the name plate.
- ▶ Only use sockets with a protective earth (PE) conductor and suitable power cable.



**WARNING! Direct contact with cold contents inside the freezer can burn unprotected skin**

- ▶ Use freezer gloves at all times when loading or unloading equipment.
-

## 2.4.2 Incorrect handling of accessories

**CAUTION! Lack of safety due to incorrect accessories or spare parts**

Accessories and spare parts that are not recommended by Eppendorf compromise the safety, function and precision of the device. Eppendorf cannot be held liable or accept any liability for damage resulting from the use of non-recommended accessories and spare parts.

- ▶ Only use accessories and original spare parts recommended by Eppendorf.
-



### 3 Product description

#### 3.1 Main illustration

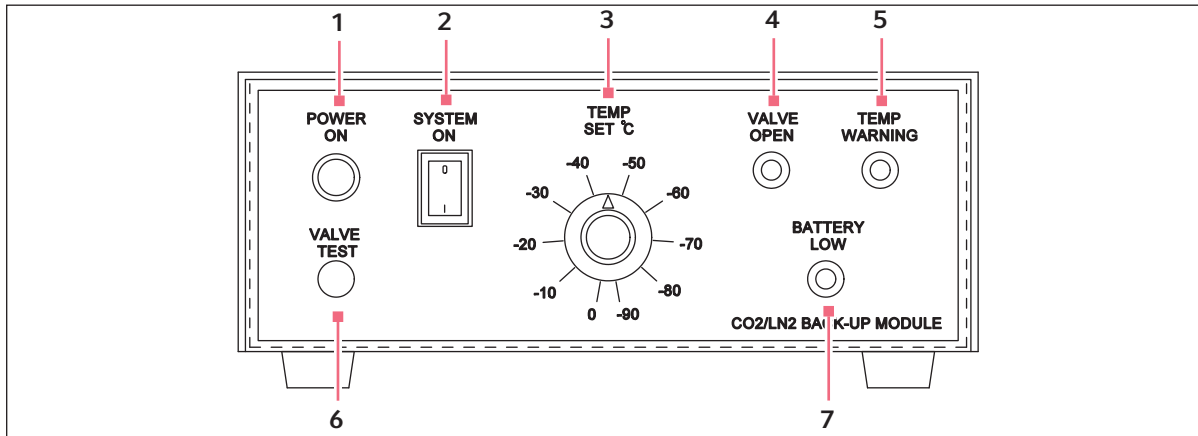

Fig. 3-1: Front view of the LN<sub>2</sub> Back-up System

#### 1 Power On LED

Illuminates when device is plugged into the mains

#### 2 System On Switch

Turns the device on or off

#### 3 Temp Set Dial

Sets the back-up temperature in case of power failure

#### 4 Valve Open LED

Illuminates when LN<sub>2</sub> valve is open

#### 5 Temp Warning LED

Illuminates when internal freezer temp drops below set temperature on the Temp Set Knob

#### 6 Valve Test Button

Button to push to test LN<sub>2</sub> injection

#### 7 Battery Low LED

Illuminates when back-up battery inside device is low

**Product description**

New Brunswick LN2 Back-up System  
English (EN)

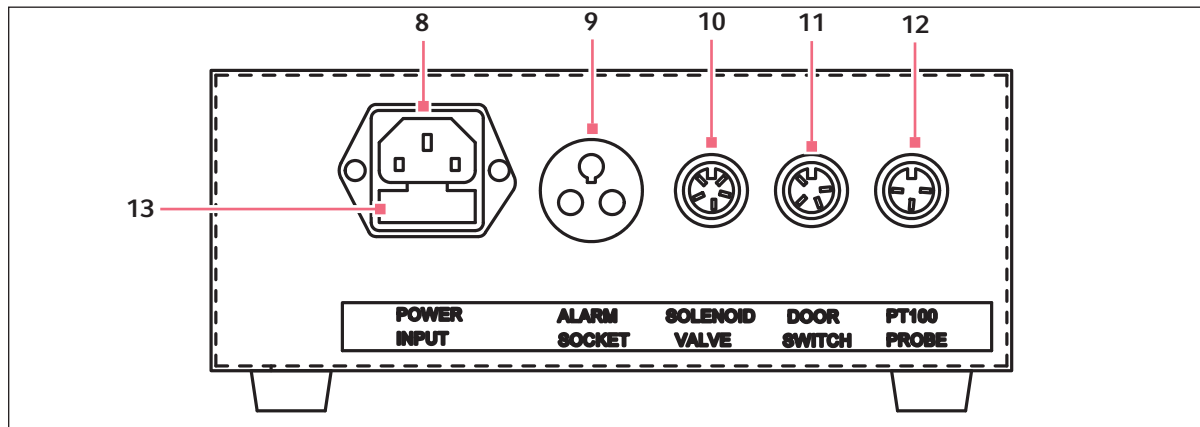

Fig. 3-2: Back view of the LN<sub>2</sub> Back-up System

**8 Power Input Socket**

Insertion point for power cord

**9 Alarm Socket****10 Solenoid Valve Socket**

5P DIN

**11 Door Switch Socket**

4P DIN

**12 PT100 Probe Socket**

3P DIN

**13 Main Fuses**

## 4 Transport, storage and disposal

### 4.1 Transport



#### NOTICE! Improper transportation

- ▶ Only transport product in its original packaging

### 4.2 Disposal

In case the product is to be disposed of, the relevant legal regulations are to be observed.

#### Information on the disposal of electrical and electronic devices in the European Community:

Within the European Community, the disposal of electrical devices is regulated by national regulations based on EU Directive 2002/96/EC pertaining to waste electrical and electronic equipment (WEEE).

According to these regulations, any devices supplied after August 13, 2005, in the business-to-business sphere, to which this product is assigned, may no longer be disposed of in municipal or domestic waste. To document this, they have been marked with the following identification:



Because disposal regulations may differ from one country to another within the EU, please contact your supplier if necessary.

In Germany, this is mandatory from March 23, 2006. From this date, the manufacturer has to offer a suitable method of return for all devices supplied after August 13, 2005. For all devices supplied before August 13, 2005, the last user is responsible for the correct disposal.



## 5 Introduction

### 5.1 Scope of manual

This manual provides the user with the necessary information for the installation and operation of the LN<sub>2</sub> Back-up System for New Brunswick Innova® and Premium ranges of Ultra Low Temperature Freezers.

### 5.2 LN<sub>2</sub> Back-up System

The LN<sub>2</sub> Back-up System system is designed to provide a means of maintaining the contents of a New Brunswick Ultra Low Temperature Freezer at a preset temperature should the power or the refrigeration system fail.

The freezer is fitted with a platinum resistance thermometer (referred to as a temperature sensor or probe) to measure the internal temperature, a solenoid valve and a door switch.

A freestanding control unit and cables are provided. Transfer lines and connectors are supplied to connect between the solenoid valve and the LN<sub>2</sub> low-pressure storage Dewar. Dewars are not provided.



A low-pressure liquid nitrogen storage Dewar with a pressure-regulated liquid withdrawal port is required. Liquid nitrogen must be used to ensure proper operation.

The backup control unit is plugged into the power supply and a temperature selected between -50 °C and -85 °C. When the temperature within the freezer rises above the selected backup temperature, the solenoid valve switches on and LN<sub>2</sub> is continuously injected into the body of the freezer.

The solenoid valve continues to inject LN<sub>2</sub> until the temperature within the freezer drops below the preset value selected on the **Temp Set** dial. If a power failure occurs, a battery within the back-up unit will continue to operate the back-up system for up to 48 hours.

When the door or lid of the freezer is opened, the door switch is activated to prevent additional gas injections while the freezer is open. This prevents the freezer user from being burned by the extremely cold gas stream.

### 5.3 Product versions

Back-up Systems	
Freezer type	Part number
Innova 115 V / 220 V 60 Hz CGA Bottle Fitting	U9044-0002
Innova 230 V 50 Hz BS341 Bottle Fitting	U9044-0004
Premium 115 V / 220 V 60 Hz CGA Bottle Fitting	U9044-0006
Premium 230 V 50 Hz BS341 Bottle Fitting	U9044-0008

**Introduction**

New Brunswick LN2 Back-up System  
English (EN)

**WARNING! Possible suffocation**

- ▶ Keep in well ventilated area
-

## 6 Installation

### 6.1 Before installation



#### **DANGER! Damage to device**

- ▶ Empty freezer before installation of device.
  - ▶ Open the door or lid of freezer and let reach ambient temperature.
- 

The back-up unit cannot be fitted to a freezer that is operating!

Before installation, empty the freezer, switch it off, and disconnect it from the power outlet. Open the door or lid and let the whole freezer reach ambient temperature.

### 6.2 Selecting the location

Select the location according to the following criteria:

- Position the control unit such that the disconnect device - the mains/power plug is easily accessible.
- Suitable mains power connection according to the ID plate
- Stable, level base
- Well ventilated area
- Ambient temperature of 5 °C to 40 °C
- Ambient humidity of 80 % at 31 °C
- Ambient humidity of 50 % at 40 °C
- Up to 2000 m

### 6.3 Unpacking the device



#### **NOTICE! Damage due to incorrect usage**

- ▶ Only use the device for the intended use described in the operating manual.
  - ▶ Ensure adequate material resistance when using chemical substances.
  - ▶ If in doubt, contact Eppendorf.
- 



Keep the packing material and transport securing device for later transport or storage.

Carefully unwrap the back-up unit and retain the packing materials for possible future use.

Check that all the items listed on the packingshipping list are present. Inspect all items for damage that may have occurred during delivery. Report any damage and/or deficiencies within 14 days to your nearest New Brunswick Scientific Company (using Customer Satisfaction Form available online at [www.nbsc.com/CustomerFeedback.aspx](http://www.nbsc.com/CustomerFeedback.aspx)).

**Installation**

New Brunswick LN2 Back-up System  
English (EN)

## 6.4 Temperature sensor installation

The temperature sensor is fitted to the freezer through the port fitted with a nylon plug. The hole is located on either (a) the top panel, in the rear right-hand corner on upright models (except for the Model U101: see note below), or (b) inside the compressor compartment on chest models.

**On the U101 Innova freezer, the temperature sensor port is located on the left-hand side wall.**

### 6.4.1 Temperature sensor installation for upright freezers

1. The temperature sensor is fitted through one of the two plugged ports.
2. Remove the plug that is **not** surrounded by four screws and set it aside.
3. Using the replacement blanking plug provided, insert the sensor through the hole in the plug and seal it by pressing the rubber grommet located on the sensor cable into the hole.
4. Insert the temperature sensor through one of the insulation tubes provided and push the sensor and insulation tube into the cabinet port. Install the nylon plug by pressing it into the hole.
5. Inside the freezer cabinet, position the LN<sub>2</sub> temperature sensor next to the existing freezer temperature sensor, located halfway down the rear right-hand corner of the cabinet. (For the Model U101, skip now to step 9. For all other models, complete steps 6 through 8 only.)
6. Remove the freezer temperature sensor cover inside the freezer cabinet and position the two sensors side by side. Fasten with the cable ties provided.
7. Replace temperature sensor cover.
8. Using two more cable ties, secure the temperature sensor cable to the two fixing points (plastic clips) attached to the cabinet of the freezer.
9. *For the Model U101 freezer, complete Steps 9-12:* the temperature sensor cable should pass under the fixed shelf and be located on the right side of the internal cabinet. The probe should be attached directly next to the existing freezer temperature probe.
10. Remove the freezer temperature sensor cover inside the freezer cabinet and position the two sensors side by side. Fasten with the cable ties provided.
11. Replace the temperature sensor cover.
12. Using two more cable ties, secure the temperature sensor cable to the two fixing points (plastic clips) attached to the cabinet of the freezer.

### 6.4.2 Temperature sensor installation for chest freezers

1. Remove the right side cover of the freezer to expose the compressor compartment.
2. Looking into the compressor compartment, at the top left-hand corner, the existing freezer temperature sensor can be seen passing into the freezer cabinet. The LN<sub>2</sub> temperature sensor should be fitted through the same port.
3. Create a hole through the insulation next to the freezer temperature sensor by inserting a length of 1/4-inch or ~6mm metal rod or tube through the insulation to create a passage for the probe (keeping the rod or tube perpendicular to the cabinet wall when inserting through the insulation).
4. After creating the new hole, push the LN<sub>2</sub> temperature sensor through the hole and pull enough temperature sensor cable through the hole to reach the freezer temperature sensor, located approximately halfway down the front right corner, inside the freezer cabinet.



5. Remove freezer temperature sensor cover and position the two sensors side-by-side.
6. Fasten the two sensors with the plastic cable ties provided.
7. Replace the temperature sensor cover.

## 6.5 Installing the insulated transfer hose

The insulated transfer hose consists of a 2 m (6.6 ft) hose that is surrounded by a tube of thermal insulation.

### 6.5.1 For upright freezers (including Model U101)

1. Attach the smaller fitting of the insulated transfer hose to the solenoid valve assembly.
2. Rotate the fitting clockwise to tighten.

### 6.5.2 For chest freezers

1. Remove the compressor housing panel.
2. Remove the 2-inch blanking plug from the rear panel of the freezer.
3. Insert the smaller fitting of the insulated transfer hose through the port; pull enough hose through to attach to the solenoid valve assembly.
4. Rotate fitting clockwise to tighten.

## 6.6 Solenoid valve to freezer installation

The solenoid valve is fitted to the freezer through the port fitted with a nylon plug and surrounded by a ring of four screws. The port is located (a) on the top panel, in the rear right-hand corner on Upright models (except for the Model U101: see NOTE below), or (b) inside the compressor compartment on Chest models.

**NOTE: On the U101 Innova freezer, the injector port is located on the left-hand side wall.**

### 6.6.1 Solenoid valve installation for upright freezers

1. Remove the nylon plug and the 4 screws surrounding the plug. Retain the screws for reuse. The washers can be discarded.
2. Remove the protective cap from the end of the solenoid valve injector pipe.
3. Holding the solenoid valve, slide one of the short insulation tubes provided over the copper injection pipe.
4. Push the injector and insulation tube into the exposed port in the freezer cabinet.
5. Align the Z-shaped bracket attached to the solenoid valve body over the four mounting holes and, using the four screws previously set aside, secure the bracket to the body of the freezer.
6. Tighten screws evenly to lock the solenoid valve into position.

**Installation**

New Brunswick LN<sub>2</sub> Back-up System  
English (EN)

### 6.6.2 Solenoid valve installation for chest freezers

The port for the solenoid assembly is located inside the upper right-hand side of the compressor compartment.

1. Make sure the manifold-to-injector transfer line assembly passes through the port in the rear panel of the freezer and the solenoid valve cable to the control unit passes through the grommet on the upper rear panel.
2. Install the solenoid valve assembly to the port inside the compressor compartment as described in steps 1 through 6 for **Upright** Freezers.

## 6.7 LN<sub>2</sub> gas supply installation



The transfer line connector is 3/4 inch - 16 UNF, female union. Two transfer line adaptors are also supplied, 1/2 and 3/8 inch NPT, to adapt the transfer line to the supplied Dewar if necessary. Before installation, verify, with your local gas supply company, the correct adaptor to use with the supplied Dewar.

1. Position the LN<sub>2</sub> Dewar within 1 meter (3.3 ft) of the freezer. To prevent injury or equipment damage, secure the Dewar to make sure it cannot fall or roll.
2. Connect the insulated transfer line to the regulated liquid withdrawal port of the LN<sub>2</sub> Dewar.

## 6.8 Test for gas leaks

Before continuing with installation, ensure there are no gas leaks with the following procedure:



---

**WARNING! Failure of system**

- ▶ Check for leaks to avoid failure of system
- 

1. Ensure all fittings are tight before testing.
2. Apply liquid soap solution on each joint.
3. Turn LN<sub>2</sub> on.  
Bubbling or foaming will identify leaks.
4. Retighten the fitting or replace the seals if necessary.

## 6.9 Door switch installation

The magnetic door switch is composed of two separate items (magnet and magnet sensor) and is installed on (a) the top left-hand surface of the door on Upright models (top right-hand surface of the door on the model U101) or (b) the rear, right-hand surface of the lid on Chest models.

For Innova Freezers and the Premium U700, use the two, small metal adapter plates supplied. Install the magnet and magnetic sensor to the adaptor plates using the attached fittings. When attaching to a Premium freezer, the adapter plates are not used and the magnetic sensor assembly is attached directly to the freezer cabinet and door.

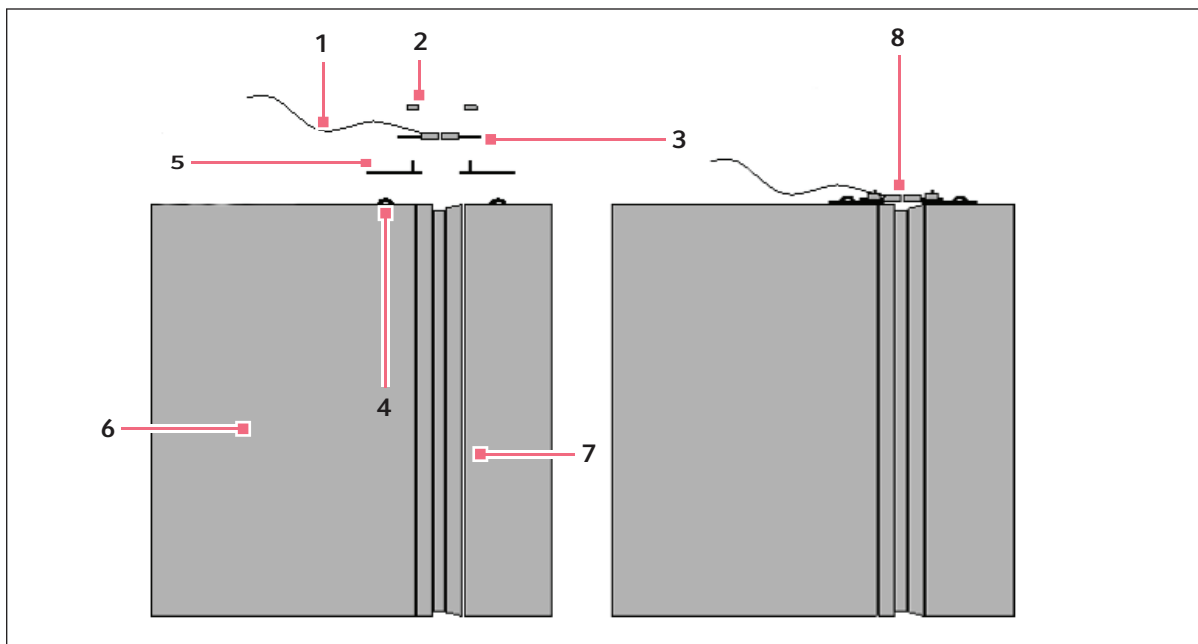

- |  |   |
|--|---|
| <p><b>1 Door switch cable</b><br/>(Attached to sensor)</p> <p><b>2 Attachment nuts</b></p> <p><b>3 Magnet</b></p> <p><b>4 Attachment screws</b><br/>(Must be removed before installation. Retain screws on door for attaching the magnet.)</p> | <p><b>5 Adapter plates</b></p> <p><b>6 Freezer case</b></p> <p><b>7 Freezer door</b></p> <p><b>8 Installed doorswitch</b></p> |
|--|---|

1. Remove the two screws on the lid or door of the freezer and retain for re-use.
2. Fasten the door switch **magnet** in place using the two screws removed above. The magnet should face toward the case of the freezer. The magnet portion of the sensor can be identified by the lack of electrical wires
3. Remove the screws on the case of the freezer.

**Installation**

New Brunswick LN2 Back-up System  
English (EN)

**CAUTION! Failure of system to operate correctly**

- ▶ Ensure magnetic door switch is installed correctly
- 

4. Using the screws provided, fasten the magnet sensor that has the electrical cable attached.
5. Close the lid or door to check that the two parts of the switch do not touch. There should be a gap of no more than 3 - 10 mm (0.12 - 0.4 inches).
6. If gap is larger than 10 mm, or less than 3 mm, loosen the screws and adjust the magnet until the gap is corrected.
7. Tighten screws.

## 6.10 Installing cables to back of control unit

Note: Some kits are supplied with more than one removable power cord. Use the power cord that matches your power receptacle. Check the voltage rating plate on the underside of the control unit to confirm that the system is compatible with your laboratory power supply.

1. Place the control unit on top surface of upright freezer, or on compressor compartment of chest freezer.
  2. Plug solenoid valve cable into appropriate socket (labelled **Solenoid Valve** on back of unit).
  3. Plug temperature sensor cable into appropriate socket (labelled **PT100 Probe**).
  4. Plug door switch cable into the appropriate socket (labelled **Door Switch**).
- 

**CAUTION! Failure of system**

- ▶ Ensure that the control unit's voltage rating matches you electrical supply
  - ▶ Do not plug in unit if you are not sure of electrical supply voltage rating
- 

5. Choose appropriate power cord to use. Sytem is capable of operating within this voltage range: 100/240 V 50/60 Hz
6. Insert power cord into socket on back of system.
7. Plug power cord into mains.



Only use approved power cords with the correct rating. Contact Eppendorf sales office for replacement cords.

## 7 Operation

### 7.1 Turning the control unit on

1. Plug the power cord into the mains.  
The green **Power On** LED illuminates.
2. Turn the **System On** switch to the on position.  
The control unit will beep. The alarm may sound if the control unit has not been switched on for some time. In this case, the alarm will continue to sound until the battery has been charged or replaced with a fully charged battery.  
The **Temp Warning** light will illuminate, indicating the temperature in the freezer is warmer than the temperature set on the Back-up Unit.

### 7.2 Testing the solenoid valve

1. Unplug freezer.
2. Close the door or lid of freezer.
3. Turn the **System On** switch on.
4. Turn LN<sub>2</sub> supply on.  
The **Valve Open** LED will pulse on and off indicating gas injection.



#### **WARNING! High pressure**

- ▶ Do not keep Valve open for more than 2 seconds at a time.
- ▶ Allow 15 seconds before pushing **Valve Test** button again.

5. Push the **Valve Test** button and hold for no more than 2 seconds at a time.  
The **Valve Open** light will illuminate and LN<sub>2</sub> will be injected into the freezer for however long you push the **Valve Test** button.
6. Release the **Valve Test** button.  
The front panel LED's will illuminate in sequence, in a clockwise direction.
7. Confirm that gas has been flowing by determining the presence of frozen condensation around the injector and on the freezer's shelf.

### 7.3 Testing door switch



#### **WARNING! Extremely cold gas**

You may be burned by cold gas.

- ▶ Open door or lid of freezer with caution
- ▶ The door switch is **NOT** designed as a safety interlock.

1. Carefully open the door or lid of the freezer 5 cm (about 2 in).  
LN<sub>2</sub> should not be injected into freezer.

**Operation**

New Brunswick LN<sub>2</sub> Back-up System  
English (EN)

2. Check for frozen condensation around injector and freezer shelf. Frozen condensation indicates LN<sub>2</sub> Back-up System is working.
3. Push **Valve Test** button.  
Gas should **not** be injected into freezer.  
**Valve Open** light should not illuminate.

#### 7.4 Testing back-up system operation

1. Turn off LN<sub>2</sub> Back-up System with the **System On** switch.
2. Turn on freezer.
3. Set freezer to to desired temperature and wait until temperature is reached.
4. Set **Temp Set** dial on the control unit to 10 °C **higher** than the freezer's temperature.
5. Flip **System On** switch on.  
The **Temperature Warning** LED and **Valve Open** LED remain off. This is because the temperature of freezer is lower than temperature set on **Temp Set** dial.
6. Change **Temp Set** dial to 10 °C **lower** than freezer's temperature .  
The **Temperature Warning** LED will turn on indicating that the temperature in the freezer is below the temperature set on the dial of the control unit.  
The **Valve Open** LED will flash on and off indicating gas is being injected into the freezer.
7. Unplug LN<sub>2</sub> Back-up System from mains.  
The **Power On** LED will turn off. The device is now operating on battery back-up. There should be no change in temperature in the freezer while LN<sub>2</sub> Back-up System is in operation.
8. Plug the LN<sub>2</sub> Back-up System back into mains.
9. Reset the **Temp Set** dial to the desired temperature at which the device should turn on in the event of power failure.
10. Verify that the gas supply is still on and the freezer is operating.  
The **Temp Warning** should be off indicating that the freezer temperature is below the temperature set on the **Temp Set** knob.  
The **Valve Open** LED should be off indicating that gas is not being injected into the freezer.  
The **Power On** LED should be on indicating that the LN<sub>2</sub> Back-up System is plugged into the mains.

#### 7.5 Battery back-up

The LN<sub>2</sub> Back-up System contains a rechargeable battery in case of power failure.

If the LN<sub>2</sub> Back-up System is plugged into the mains, and the **Power On** LED is illuminated, the battery is being charged.

If the external power supply fails, the back-up battery will power the LN<sub>2</sub> Back-up System for up to 48 hours, depending upon ambient conditions. The lower the ambient temperature, the longer the back-up battery will run.

When the back-up battery's voltage drops below 11.4 volts, the **Battery Low** LED will illuminate and an alarm will sound.

## 7.6 Alarm system monitoring socket



### WARNING! Hazardous voltages

- ▶ Hazardous voltages must not be connected to the remote alarm socket. Maximum rating is 24 volts, 1 amp.

The LN<sub>2</sub> Back-up System is designed with a fixed socket at the rear labelled **Alarm Socket**, and a plug for external monitoring purposes.

Within the control unit, the alarm socket is connected to volt-free, switching contacts rated at 24 volts, 1 amp. In normal operation, pin 1 (E) is connected to pin 2 (L) and in the alarm condition, pin 1 (E) is connected to pin 3 (N).



### NOTICE!

- ▶ External device shall secure double reinforced insulation from mains voltage in accordance with 61010-1

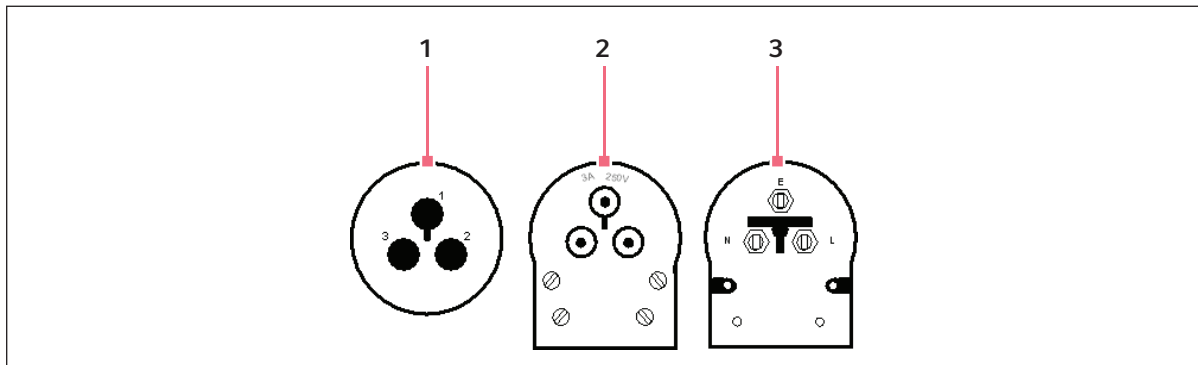

1 Freezer Socket

3 Alarm Plug (internal view)

2 Alarm Plug (external view)

The alarm plug can be used to connect to a remote alarm device or central monitoring system





## 8 Maintenance

---



### CAUTION!

- ▶ Maintenance, service and repair work should be carried out only by qualified personnel who have been authorized by Eppendorf.
  - ▶ Failure to use authorized service agents may invalidate the warranty.
- 

### 8.1 Cleaning

---



### DANGER! Electric shock

- ▶ Switch the device off and pull the power plug out of the socket before beginning work.
- 



### NOTICE! Damage due to incorrect cleaning agent or sharp objects

Unsuitable cleaning agents can damage the display, surfaces and printing.

- ▶ Never use corrosive cleaning agents, strong solvents or abrasive polishes.
  - ▶ Do not use acetone to clean the device.
  - ▶ Do not use sharp objects to clean the device.
- 

#### 8.1.1 Cleaning the device

- ▶ Clean the accessories and all accessible surfaces of the device once a month or if they have become significantly dirty.
- ▶ Use a mild cleaning agent and a damp cloth.

#### 8.1.2 Cleaning the surrounding area

- ▶ Keep the air around the device dust-free.
- ▶ Clean the area around the device on a regular basis.

## 8.2 LN<sub>2</sub> supplies

We recommend that a record sheet be placed on or near the freezer, and that a routine check of the liquid nitrogen remaining in the Dewar be allocated to a staff member. Record the measurements on the record sheet. All gas supplies can leak away with time. The majority of LN<sub>2</sub> backup system failures are not equipment failures; they are rather due to empty Dewars, resulting from lack of routine checks.

**Maintenance**

New Brunswick LN<sub>2</sub> Back-up System  
English (EN)

### 8.3 Electrical connection maintenance

All electrical cables should be checked every month. Failure to do so may result in failure of the device. If damage is found, do **not** attempt to repair by yourself.

1. Turn off LN<sub>2</sub> Back-up System and unplug the power cord from the mains.
2. Inspect the power cord, door switch cable, solenoid cable, and temperature sensor cable for cuts or other damage.
3. If damage is found, contact a qualified service engineer to replace the damaged parts.

### 8.4 Battery maintenance

**WARNING! Battery**

- ▶ Do not attempt to replace or repair battery by yourself.
  - ▶ The control unit contains mains voltage.
- 

The LN<sub>2</sub> Back-up System runs on a rechargeable battery during a power failure.

Contact a qualified service engineer to replace the battery every 5 years or when the Low Battery Alarm sounds despite it being plugged into the mains.

### 8.5 Transfer line and manifold maintenance

At least once annually, a qualified service engineer should inspect the LN<sub>2</sub> transfer line from the Dewar to the injector for damage or deterioration.

### 8.6 Maintenance forms

Period	Place the task	Task	Personnel
Weekly	Near device	Clean with damp rag if necessary.	User
Weekly	Near LN <sub>2</sub> supply	Weigh LN <sub>2</sub> supplies to see if they are full.	User
Monthly	Near device	Check for cuts or abrasions on all electrical wires.	User
		Inspect all hoses for cuts, chaffing, and squashing.	
		Inspect hose connection to bottle and seal connection on the bottle. There should be no damage or corrosion.	
		Inspect manifold plugs and seals. There should be no mechanical damage or corrosion.	
		Inspect LN <sub>2</sub> supply connection and solenoid valve connection. There should be no damage or corrosion.	
Once every 5 years or when battery fails	Near device	Replace battery.	Qualified service engineer

### 8.7 CO<sub>2</sub>/LN<sub>2</sub> back-up system service checklist



**NOTICE!**

- ▶ Service should check the following points.
- ▶ Refer to user manual sections as indicated.

- |    |   |   |
|----|---|---|
| 1. | Check Back-up system components for wear and any damage.  | □ |
| 2. | Check system and gas supply installation (see <i>LN<sub>2</sub> gas supply installation on p. 18</i> ). | □ |
| 3. | Check system connections for leaks (see <i>Test for gas leaks on p. 18</i> ).                           | □ |
| 4. | Test the injector valve operation (see <i>Testing the solenoid valve on p. 21</i> ).                    | □ |
| 5. | Test the door switch operation (see <i>Testing door switch on p. 21</i> ).                              | □ |
| 6. | Test overall system operation (see <i>Testing back-up system operation on p. 22</i> ).                  | □ |

**Maintenance**

New Brunswick LN2 Back-up System  
English (EN)

**Safety checklist**

1. Observe any warning or caution symbols or statements (see *Warnings for intended use on p. 7*).
2. Operating personnel should always wear the appropriate personal protective equipment (*i.e.* cold insulating gloves EN511, *etc.*).
3. As with any equipment that uses CO<sub>2</sub>/LN<sub>2</sub> gas, there is a likelihood of oxygen depletion in the vicinity of the equipment. It is important to assess the work site to ensure there is suitable and sufficient ventilation. If restricted ventilation is suspected, then other methods of ensuring a safe environment should be considered.

For information on use, safety, handling and storage of refrigerated liquids/gases refer the manufacturers safety data sheets.

**Service verification**

To be completed by service engineer.

The following equipment has be serviced and checked by an approved engineer and declared safe to use.

**Product:**

---

**Serial No.:**

---

**Date:**

---

**Signature:**

---

**Address, Division, Telephone:**

---

## 9 Technical data

### 9.1 Performance

The LN<sub>2</sub> Back-up System is capable of maintaining a freezer maximum internal temperature of -80 °C in an ambient temperature of +32 °C.

### 9.2 Weight/dimensions

#### 9.2.1 Device dimensions

Height	86.5 mm (3.4 inch)
Width	203 mm (8.0 inch)
Depth	342 mm (13.5 inch)

#### 9.2.2 Device weight

Weight of LN <sub>2</sub> Back-up System	5.6 kg (12.3 lb)
--	------------------

### 9.3 Cable and transfer line lengths

Power Cord	3 m (9.8 ft)
Temperature sensor cable	2.75 m (9 ft)
Solenoid valve cable	0.9 m (3 ft)
Door switch cable	1.2 m (4 ft)
Insulated transfer line, LN <sub>2</sub> to solenoid valve	2 m (6.6 ft)

### 9.4 Power supply

Single phase, 100/240 V, 50/60 Hz, 1.5 Amp

### 9.5 Fuses

The control unit input power socket is fitted with two fuses: Live and Neutral: Specification 2A 250 V 20mm ceramic T (T2AH250V).

**Technical data**

New Brunswick LN2 Back-up System  
English (EN)

## 9.6 Ambient conditions

### 9.6.1 Device operating environment

Altitude	Up to 2000 m
Minimum ambient temperature	5 °C
Maximum ambient temperature	40 °C
Maximum humidity at 31 °C	80 %
Maximum humidity at 40 °C	50 %
Pollution degree	2

## 9.7 Gas Consumption

The consumption of gas is very difficult to specify because it is dependent on the operating conditions.

Gas consumption is affected by several factors. Consumption increases with:

- An increase in ambient temperature
- Increasing age of freezer
- Increasing age of door or lid seal
- A colder temperature set on the device
- Frequent opening of door or lid

We highly recommend that the user decide, prior to full operation, what temperature conditions the backup unit should maintain. The user should then install the system, switch the freezer off, and record the time it takes for the LN<sub>2</sub> Dewar to empty while the system maintains the desired temperature. This precaution will enable the user to select the Dewar size best suited to providing the degree of protection required. As a guide, the following chart can be used to calculate consumption:

Gas consumption was measured at the indicated temperatures, in the center of the cabinet and in an ambient temperature of 23 °C.

<b>Consumption in kg/hr (lbs/hr):</b>	<b>at -60 °C</b>	<b>at -70 °C</b>	<b>at -80 °C</b>
<b>Upright freezers (empty)</b>			
U725 Innova	2.62 (5.76)	2.75 (6.05)	3.0 (6.6)
U535 Innova	2.05 (4.51)	2.16 (4.74)	2.11 (4.63)
U101 Innova	1.13 (2.49)	1.38 (3.03)	1.79 (3.93)
U410 Premium	2.0 (4.4)	2.2 (4.84)	2.6 (5.72)
U570 Premium	2.25 (4.95)	2.7 (5.94)	3.3 (7.26)
<b>Chest freezers (empty)</b>			
C760 Innova	2.85 (6.3)	3.0 (6.6)	3.2 (7.0)
C585 Innova	2.6 (5.72)	2.85 (6.3)	3.1 (6.82)
C660 Premium	2.67 (5.86)	2.83 (6.22)	3.03 (6.63)
C340 Premium	1.99 (4.37)	2.07 (4.58)	1.84 (4.04)

## 9.8 LN<sub>2</sub> Supplies

Consult your local gas supplier for suitable LN<sub>2</sub> supplies. A low-pressure liquid nitrogen storage Dewar (or other suitable storage tank) with a liquid withdrawal port is required to properly utilize the cooling properties of the liquid nitrogen. The liquid withdrawal port must have an adjustable valve with a pressure gauge. The withdrawal pressure should be set to between 6 to 8 psig (0.44 to 0.55 bar).

## 9.9 Spare parts

Parts should only be replaced/installed by a qualified service engineer.

<b>Description</b>	<b>Part Number</b>
LN <sub>2</sub> Control Unit	P0625-0570
Power Supply, 18 V, 45 - Watt	P0625-0500
Battery 12 V 7 Ah - Control unit	K0480-0020
Fuse 20 mm 2 A - Control	K0380-0610
PT100 Temperature Sensor Assembly	P0625-1410
Magnetic Door Switch Sensor Assembly	P0625-1420
Door Switch Magnet	K0400-0631
Magnetic Door Switch Adaptor Plates, Innova and Premium U700 only	P0625-0320

**Technical data**

New Brunswick LN2 Back-up System  
English (EN)

<b>Description</b>	<b>Part Number</b>
Alarm Plug, 3P-connector	K0380-0451
Black Plastic Blanking Plug, (pack of 2)	K0740-0330
Insulation Tube (2x25 mm)	P0625-0300
Tie wrap fasteners (pack of 5)	K0700-0140
Insulated Transfer Line, 2 M	P0625-0250
LN <sub>2</sub> Solenoid Valve Injector Assembly, Premium only	P0625-1430
LN <sub>2</sub> Solenoid Valve Injector Assembly, Innova only	P0625-1431
LN <sub>2</sub> Solenoid Valve Injector Tube, Premium only	P0625-0530
LN <sub>2</sub> Solenoid Valve Injector Tube, Innova only	P0625-0531
Power Cord, 230 V, 50 Hz, UK 3-pin	P0625-0193
Power Cord, 230 V, 50 Hz, Schuko	P0625-0192
Power Cord, 115 V, 60 Hz, NEMA 5-15P	P0625-0191
Power Cord, 208-220 V, 60 Hz, NEMA 5-15P	P0625-0560



9.10 Circuit Schematics

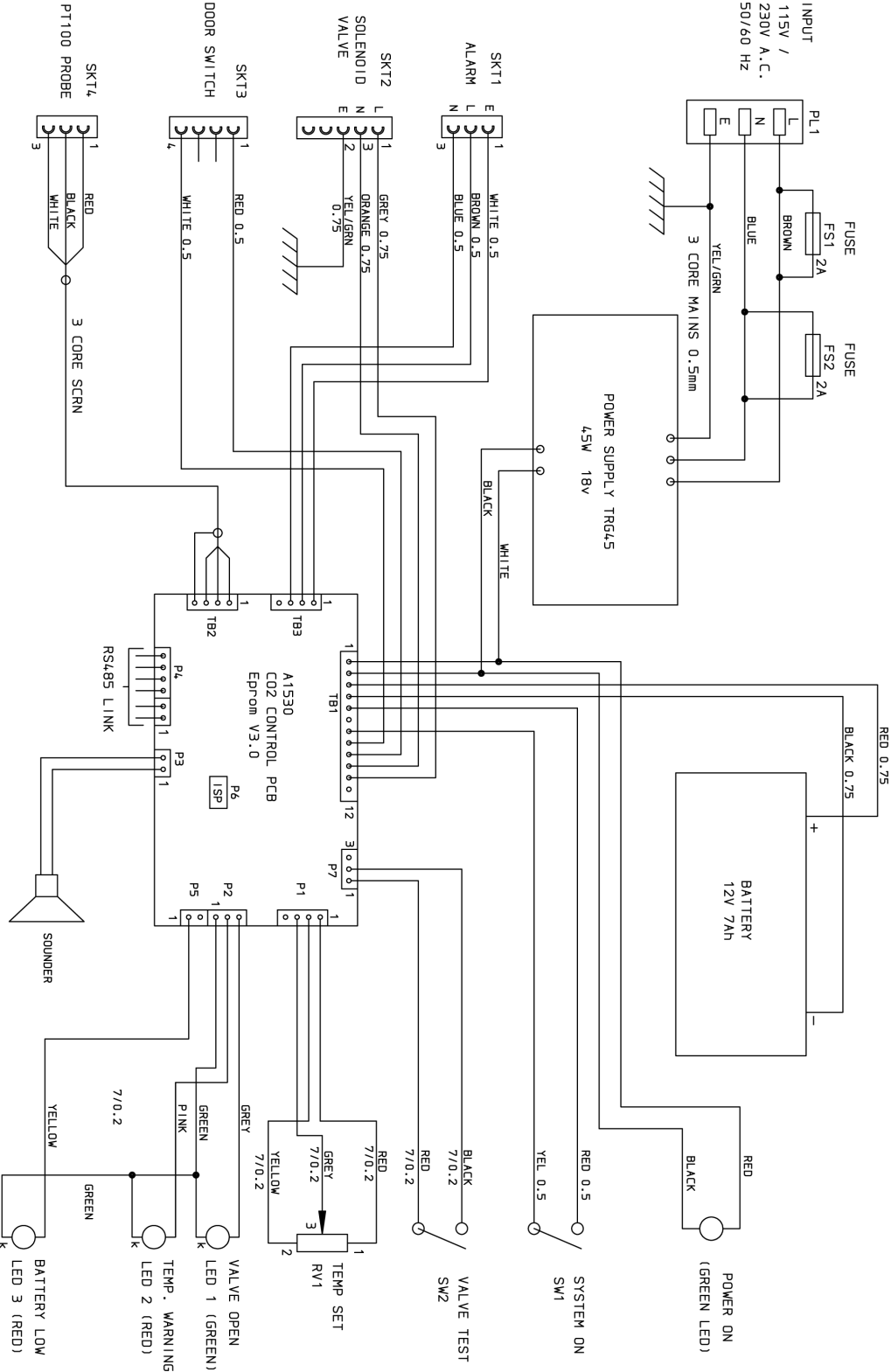

**Technical data**

New Brunswick LN2 Back-up System  
English (EN)

10 Declaration of conformity



# Declaration of Conformity

The products named below fulfill the requirements of directives and standards listed. In the case of unauthorized modifications to the product or an unintended use this declaration becomes invalid.

**Product name:**

CO2 Back Up System

LN2 Back Up System

**Product type:**

U9043-0002, U9043-0004, U9043-0006 & U9043-0008

**Relevant directives / standards:**

2006/95/EC: EN 61010-1,  
UL 61010-1, CSA C22.2 No. 61010-1 (US Voltage 60 Hz Models)

2004/108/EC: EN 61326-1  
FCC Part 15 Class B (US Voltage 60 Hz Models)

2011/65/EU

2012/19/EU

Management Board

Portfolio Management

Date: November 25, 2013

Your local distributor: [www.eppendorf.com/contact](http://www.eppendorf.com/contact)  
Eppendorf AG · 22331 Hamburg · Germany  
[eppendorf@eppendorf.com](mailto:eppendorf@eppendorf.com)

ISO 9001  
Certified

ISO 13485  
Certified

ISO 14001  
Certified

U9043-9999-00

Eppendorf® and the Eppendorf Logo are registered trademarks of Eppendorf AG Hamburg/Germany.  
All rights reserved incl. graphics and pictures. Copyright 2013 © by Eppendorf AG.

**Declaration of conformity**

New Brunswick LN2 Back-up System  
English (EN)

**WARNING!**

- ▶ Any modification or changes made to this device, unless explicitly approved by Eppendorf, will invalidate the authorization of this device. Operation of an unauthorized device is prohibited under Section 302 of the Communications Act of 1934, as amended, and Subpart 1 of Part 2 of Chapter 47 of the Code of Federal Regulations.



This equipment has been tested and found to comply with the limits for a Class B digital device, pursuant to Part 15 of the FCC Rules. These limits are designed to provide reasonable protection against harmful interference in a residential installation. This equipment generates, uses and can radiate radio frequency energy and, if not installed and used in accordance with the instructions, may cause harmful interference to radio communications. However, there is no guarantee that interference will not occur in a particular installation. If this equipment does cause harmful interference to radio or television reception, which can be determined by turning the equipment off and on, the user is encouraged to try to correct the interference by one or more of the following measures:

- Reorient or relocate the receiving antenna.
- Increase the separation between the equipment and receiver
- Connect the equipment into an outlet on a circuit different from that to which the receiver is connected.
- Consult the dealer or an experienced radio/TV technician for help.

**Index**

**A**

Alarm monitoring socket.....23  
 Altitude limit.....30  
 Ambient conditions .....30

**B**

Battery .....13, 22  
   Alarm.....23  
   Charging .....22  
   Replacement .....26

**C**

Certificate of conformity.....35  
 Circuit schematics .....33  
 Copyright.....2

**D**

Danger level .....5  
   CAUTION .....5  
   DANGER.....5  
   NOTICE .....5  
   WARNING .....5

Device overview

  Back view .....10  
   Front view .....9

Dewars.....18

Disposal .....11

Door switch .....13

**E**

Electrical connection.....26

**G**

Gas consumption.....30

**I**

Installation

  2 m (6.6 ft) Transfer line..... 17  
   Control unit.....21  
   Door switch ..... 19  
   LN2 Dewars..... 18  
   Location .....20  
   Selecting the location ..... 15  
   Solenoid valve..... 17  
   Temperature sensor..... 16  
   Unpacking device ..... 15

Intended use ..... 7

**L**

LN2 supplies ..... 31

**M**

Maintenance

  Cleaning..... 25  
   LN2 supplies..... 25  
   Transfer lines ..... 26

Manual conventions..... 5

**P**

Power on ..... 21

Product liability..... 7

Product versions ..... 13

**S**

Solenoid valve injector pipe..... 17

Spare parts.....31

Specifications

  Fuses .....29  
   Performance .....29  
   Power supply .....29

System on .....21

**T**

Temp Warning .....21

Temperature sensor ..... 16

Testing

  Door switch ..... 21

**Index**

New Brunswick LN2 Back-up System  
English (EN)

Leaks .....18  
Solenoid valve .....21  
Testing the system .....22  
Trademarks.....2

**U**

User requirement .....7



# Evaluate your manual

Give us your feedback.  
[www.eppendorf.com/manualfeedback](http://www.eppendorf.com/manualfeedback)